

MULTIPARVA 3.0 F



High energy efficiency
Minimal polluting emissions
Climate control

**Gas condensing boiler
with stainless steel exchanger**



**Installation and
maintenance manual**



CONFORMITY

The **MULTIPARVA 3.0 F** appliances comply with:

- Regulation GAR (UE) 2016/426
- Ecodesign directive 09/125/CE
- Ecolabel directive 10/30/CE
- Low voltage directive 2014/35/UE
- Electromagnetic compatibility directive 2014/30/UE
- Class of Seasonal energy efficiency in central heating mode A
- “Condensing” classification
- NOx Class 6 (< 56 mg/kWh)



For the serial number and year of manufacturer, refer to the technical data plate.

Company Management

The appliance must be installed by qualified personnel in conformity with current Technical Standards and national and/or local legislation.
All safety, installation and maintenance instructions must also be strictly observed, as stated in this manual.

INDEX

SAFETY

SAFETY WARNINGS AND REGULATIONS	4
PROHIBITED ACTIONS	4

GENERAL

DESCRIPTION	5
DEVICES	5
IDENTIFICATION	6
MAIN STRUCTURE COMPONENTS	7
TECHNICAL DATA	8
HYDRAULIC CIRCUIT - SENSORS	9
SYSTEM PUMP	10
CONTROL PANEL	11
WIRING DIAGRAM	14

INSTALLATION

PRODUCT DELIVERY	16
DIMENSIONS AND WEIGHT	16
HANDLING	17
INSTALLATION ROOM	17
NEW INSTALLATIONS OR REPLACEMENTS OF OLDER APPLIANCES	18
WATER TREATMENT	18
HYDRAULIC FITTINGS	19
EXAMPLES OF OPERATING PRINCIPLE DIAGRAMS	20
ELECTRICAL CONNECTIONS	22
CONNECTION OF OUTSIDE SENSOR (OPTIONAL)	24
GAS CONNECTION	25
FLUE EXHAUST AND EXTRACTION OF COMBUSTION AIR	26
CONDENSATE REMOVAL	28
FILLING AND DRAINING	29
MENU NAVIGATION TREES AND PROCEDURES	30
- KEY TO THE USER MENU LINES	32
- TECHNICIAN MENU NAVIGATION TREE	33
- KEY TO TECHNICIAN MENU	38
INITIAL COMMISSIONING	41
- PRELIMINARY PROCEDURES	41
- INITIAL COMMISSIONING	41
- USER INTERFACE SETTINGS VIA TECHNICIAN MENU	42
- CHECKING / MODIFYING FACTORY SETTINGS	44
- GAS CHANGE	45
- BOILER IGNITION	49
- OUTSIDE SENSOR AND CLIMATIC CURVE	54
- EXAMPLE WITH RADIATORS	55
- EXAMPLE WITH UNDERFLOOR HEATING	55
- EXAMPLE WITH FAN COIL SYSTEM	56
- 0..10V INPUT CHECK	57
- DHW REQUEST TYPE	58
SCHEDULER SETTINGS	59
TEMPORARY SHUTDOWN OR HOLIDAY SCHEDULE	61

MAINTENANCE

MAINTENANCE AND CLEANING	63
TROUBLESHOOTING	65
END OF LIFE DISPOSAL	66
- OUTDATED APPLIANCES	66
- PACKING	66



SAFETY WARNINGS AND REGULATIONS

- After unpacking the appliance, ensure that all parts are intact and complete as per the supply specifications, and if any non-conformities are found, contact the Representative that sold the appliance.
- The appliance must be installed by professionally qualified personnel, in conformity with current national and local standards and the instructions in the manual supplied with the product.
- The appliance must only be used as envisaged in the design. The manufacturer declines all liability for physical injury or damage to animals or objects caused by errors in installation, adjustments, maintenance or improper use of the appliance.
- In the event of water leakage, disconnect the appliance from the electric power mains, shut off the water supply and promptly notify the Technical Services department or other professionally qualified personnel.
- Periodically check that the hydraulic system operating pressure, in cool conditions, is approx. 2 bar. Otherwise contact the Technical Services department or other professionally qualified personnel.
- In the event of prolonged disuse of the appliance, the following procedure must be observed:
 - Set the appliance switch  and the main system switch to "OFF".
 - Shut off the fuel and mains water valves.
- This manual is an integral part of the appliance and consequently must ALWAYS accompany the appliance, also in the event of sale to another Owner or User or transfer to another system. The manual must be kept with care and in the event of damage or loss, another copy may be requested from the Technical Services department.
- **It is recommended to service the appliance at least once a year.**

Pursuant to Directive 2012/19 / EU on waste electrical and electronic equipment (WEEE) "the crossed bin symbol on the appliance and on the packaging indicates that the gas boiler, at the time of its disposal, must be collected and disposed separately from other waste (see section End of life disposal).

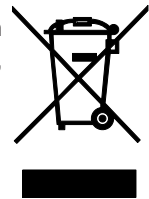

PROHIBITED ACTIONS

- **IT IS STRICTLY PROHIBITED** to allow children or disabled persons to change settings on the appliance without assistance.
- **IT IS STRICTLY PROHIBITED** to activate electrical devices or equipment such as switches, telephones, household appliances etc. if smells of fuel or uncombusted fuel are detected. In this case:
 - Open doors and windows to ventilate the room.
 - Close the fuel shut-off valve.
 - Arrange for prompt intervention of the Technical Services or other professionally qualified personnel.
- **IT IS STRICTLY PROHIBITED** to touch the appliance with bare feet or wet parts of the body.
- **IT IS STRICTLY PROHIBITED** to perform technical interventions or cleaning before disconnecting the appliance from the electrical power mains and setting the main system switch and appliance  switch to "OFF".
- **IT IS STRICTLY PROHIBITED** to modify safety devices or control devices without prior authorisation and instructions from the appliance manufacturer.
- **IT IS STRICTLY PROHIBITED** to pull, detach, or twist cables coming out of the appliance, even when disconnected from the electrical power mains.
- **IT IS STRICTLY PROHIBITED** to seal off or partially obstruct the ventilation outlets of the installation room and the appliance (if present). The ventilation outlets are essential to ensure efficient combustion.
- **IT IS STRICTLY PROHIBITED** to obstruct the condensate drain outlet.
- **IT IS STRICTLY PROHIBITED** to leave containers of flammable substances in the same room as the appliance.
- **IT IS STRICTLY PROHIBITED** to dispose of packaging into the environment as this constitutes a potential source of danger. It must therefore be disposed of in accordance with current legislation in the place of use.

DESCRIPTION

The aluminium boilers in the range **MULTIPARVA 3.0 F** are condensing heat generators, designed to heat rooms, and in combination with a storage tank, for the production of domestic hot water.

They comprise:

- a steel heat exchanger, with low water content and generously sized exchange surface to optimise energy efficiency and heating output;
- a full pre-mix microflame burner in stainless steel, to guarantee high modulation ratios, combustion stability and low pollutant emissions (NOx Class = 6);
- a variable speed blower, required for air/gas modulation and mixing;
- a combustion circuit, which can be “type C” (room-sealed) or “type B” (open-flued), with respect to the installation environment, and on the basis of the flue exhaust configuration on site;
- command-control electronics, which if equipped with outside sensor enables adjustment of the supply temperature on the basis of the outside temperature. The appliance thus only provides the heat effectively needed by the utility, avoiding energy waste. The unit is fitted with self-diagnostics with a display of the error codes and operating parameters at the time of the fault, thereby simplifying tasks for the Technical Services department.

Also, during periods of prolonged disuse or holidays, the appliance remains protected by the Anti-freeze Function, which is activated automatically when the supply temperature falls to 5°C and shuts off when it returns to 15°C. Obviously the gas and electrical mains supplies must be active during these periods.

The design phase adopted specific solutions to:

- obtain a constantly optimal air/gas mix;
- minimise dispersions;
- reduce noise levels to a minimum.

The **MULTIPARVA 3.0 F** boilers are designed for connection to 0-10 V DC controls and for operation in cascade, in sets of up to 6 units, and can be equipped with various system accessories, such as the mix bottle or water shut-off valve, and the INAIL unit, which all simplify the work of the installer and comply with compulsory Italian legal requirements.

The MULTIPARVA 3.0 F boilers are equipped with 5 litres expansion vessel, safety drain valve and water pump.

The MULTIPARVA 3.0 N boilers are without expansion vessel, safety drain valve and water pump.

DEVICES

MULTIPARVA 3.0 F appliances are equipped with the following safety, control and adjustment devices:

- Sensor on the appliance heat exchanger, to ensure thermal cut-out when the temperature reading exceeds the maximum admissible value. This is reset manually via the DSP keypad.
- Water pressure sensor: this intervenes when the hydraulic circuit pressure falls below 0.5 bar.
- Flue safety sensor: this intervenes when the flue temperature is too high.
- Hydraulic circuit diagnostics to protect the boiler against:
 - temperature overload, by checking the difference in temperatures on supply and return (ΔT);
 - inadequate water circulation in the heat exchanger.
- Siphon pressure switch that turn off the burner when the pressure inside the combustion chamber overcome 700 Pa.

WARNING

- If a safety devices trips, this means that there is a potentially hazardous appliance malfunction. In this case contact Technical Services as soon as possible for assistance.

IDENTIFICATION

The appliance is identified by means of:
- the **Technical data plate** affixed to the casing.

GENERAL

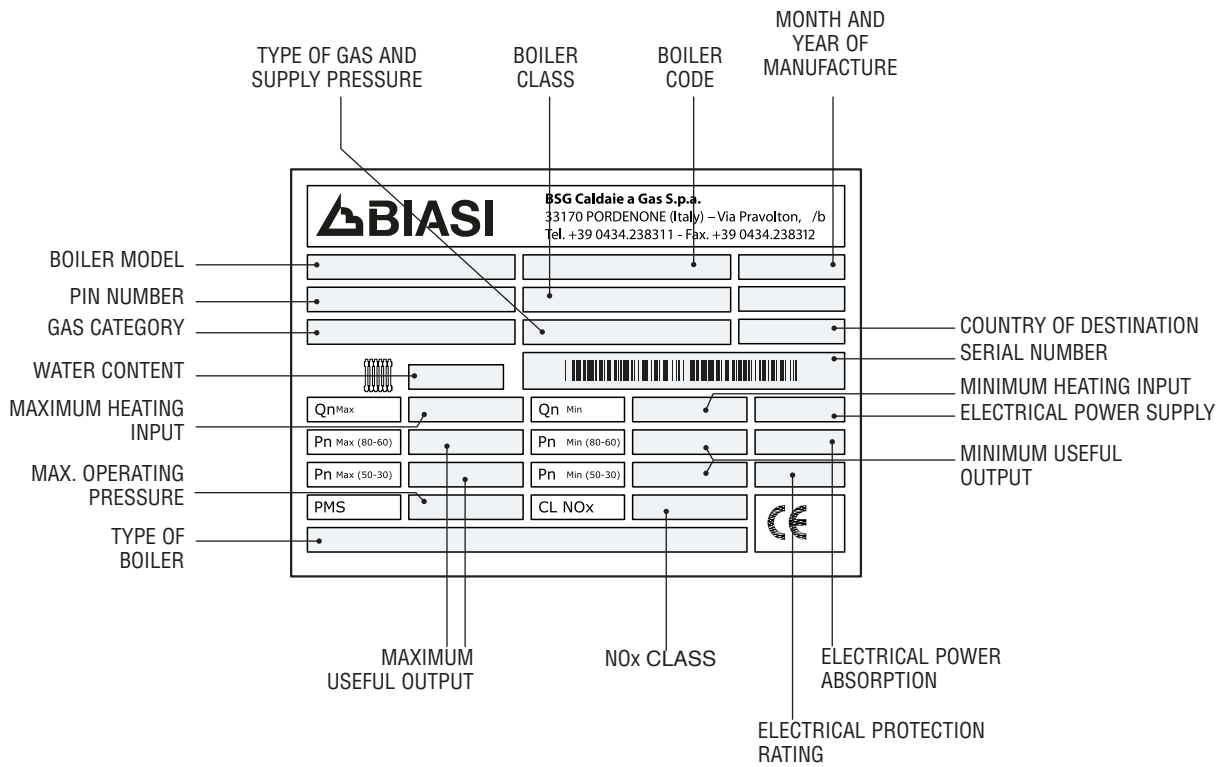

WARNING

- Any tampering, removal or elimination of the technical data plate or other element will prevent secure identification of the product, creating problems with installation and maintenance operations.

MAIN STRUCTURE COMPONENTS

M154HE.35/F - M154HE.45/F - M155HE.70/F

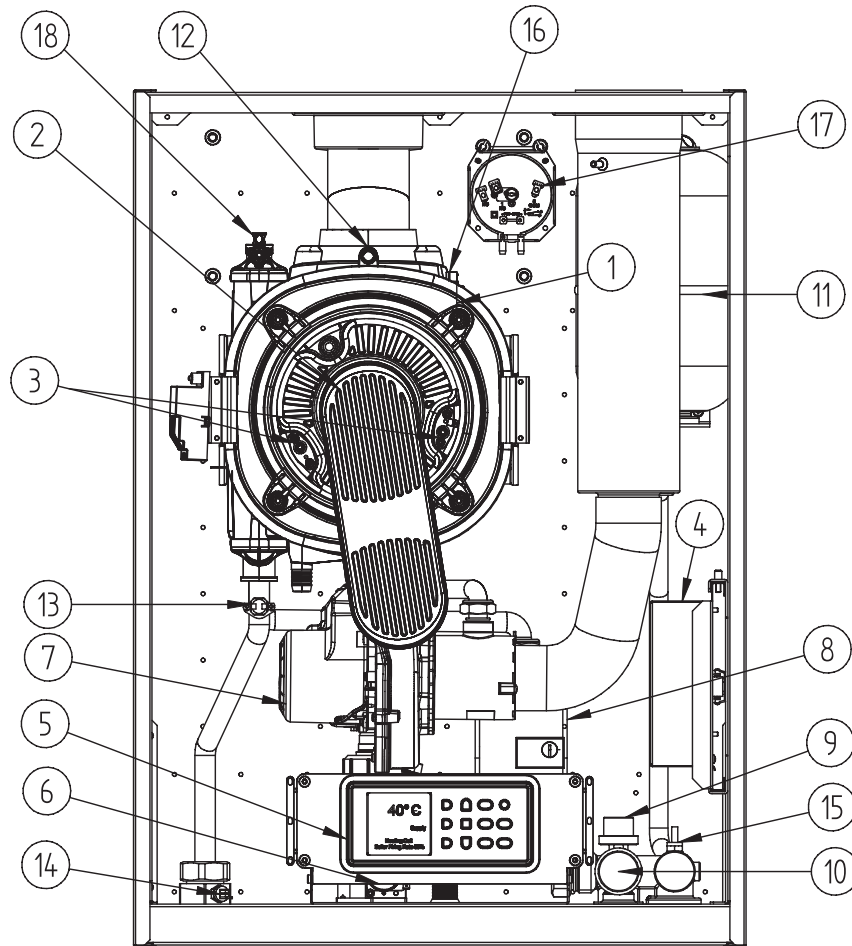

- 1 Primary condensing exchanger
- 2 Burner
- 3 Electrodes (Ignition and Flame Detector)
- 4 Electronic Board
- 5 Display
- 6 Gas Valve
- 7 Fan
- 8 Modulating Pump
- 9 Pressure trasducer
- 10 Safety drain valve (4 bar)
- 11 Expansion vessel
- 12 Flue sensor
- 13 Safety thermostat
- 14 NTC heating supply sensor
- 15 NTC heating return sensor
- 16 Thermal fuse
- 17 Siphon pressure switch
- 18 Manual purge valve

TECHNICAL DATA

DESCRIPTION	MULTIPARVA 3.0 F			
	154HE.35/F	M154HE.45/F	M155HE.70/F	
Fuel	G20 (20 mbar) - G31 (37 mbar)			
Destination Country(s)	EU			
Appliance category	II2H3P			
Type of appliance	B23, C13, C33, C43, C53, C63, C83, C13X			
Max. nominal heating input (Qn)	34,8	45,0	69,9	kW
Min. heating input (Qmin)	5,0	5,0	7,7	kW
Max. nominal heating output (80-60°C)	33,9	43,8	68	kW
Min. heating output (80-60°C)	4,8	4,8	7,5	kW
Max. nominal heating output (50-30°C)	36,8	46,4	74,5	kW
Min. heating output (50-30°C)	5,3	5,3	8,1	kW
EFFICIENCY				
Useful efficiency at max. Qn (80-60°C)	97,3	97,3	97,3	%
Useful efficiency at min. Qn (80-60°C)	96,6	96,5	97,2	%
Useful efficiency at max. Qn (50-30°C)	105,7	103,1	106,6	%
Useful efficiency at min. Qn (50-30°C)	106,6	106,7	105,8	%
Useful efficiency at 30% load (return 30°C)	108,1	108,1	108,4	%
Max gas consumption G20	3,7	4,7	7,4	m ³ /h
Min gas consumption G20	0,5	0,5	0,8	m ³ /h
Max gas consumption G31	1,4	1,9	2,7	m ³ /h
Min gas consumption G31	0,2	0,2	0,3	m ³ /h
Class of seasonal efficiency in heating mode	A	A	A	
UE 813/2013 EFFICIENCY				
η4	87,5	87,5	87,4	%
η1	97,3	97,3	97,6	%
EMISSIONS				
Flue temperature (80-60°C) a Qn	65 - 80			°C
Flue temperature (80-60°C) a Qmin	55 - 65			°C
Flue temperature (50-30°C) min/max	35 - 45			°C
Max condensate production at Qn	5,5	7	11	l/h
Mass Flue flow rate at Qn	0,0166	0,0213	0,0322	kg/sec
Mass Flue flow rate at Qmin	0,0024	0,0024	0,0036	kg/sec
CO2 min/max (G20)	8,8/9,1	8,8/9,1	9,1/9,4	%
CO2 min/max (G31)	9,6/9,9	9,6/10,1	9,8/10	%
CO at Qn (G20)	85	110	180	ppm
CO at Qn (G31)	60	95	110	ppm
NOx	25	29	31	mg/kWh
NOx Class	6			
ELECTRICAL DATA				
Max electrical absorption @ 20°K	80	120	230	W
Power supply voltage	230~50			V~Hz
Protection rating	IPX4D			
BOILER				
Max operating pressure	4.5			bar
Water Safety valve (only /F model)	4			bar
Max operating temperature	85			°C
Max admissible temperature	110			°C
Max Δt supply/return	35			
Water flow nominal Δt (20°K)	1,5	1,9	3,0	m ³ /h
Boiler water content	2,74	2,74	3,52	l
Residual Head Δt _{nom} =20°K	5,5	3,5	3,8	mH ₂ O
FLUE EXHAUST				
Flue/air inlet fitting ø	100/100			mm
Max length coaxial pipe ø 160/110	6			m
Max length of separate pipes ø 100/100 (G20)	10	14	15	m
Residual air/flue head available (flue ø100/flue ø80) (G20)	110/90	140/120	190/160	Pa
Residual air/flue head available (flue ø100/flue ø80) (G31)	110/90	140/120	190/160	Pa
DIMENSIONS and WEIGHTS				
Width	600			mm
Depth	480			mm
Height	840			mm
Weight	60	60	69	kg

HYDRAULIC CIRCUIT - SENSORS

Operating principle diagram

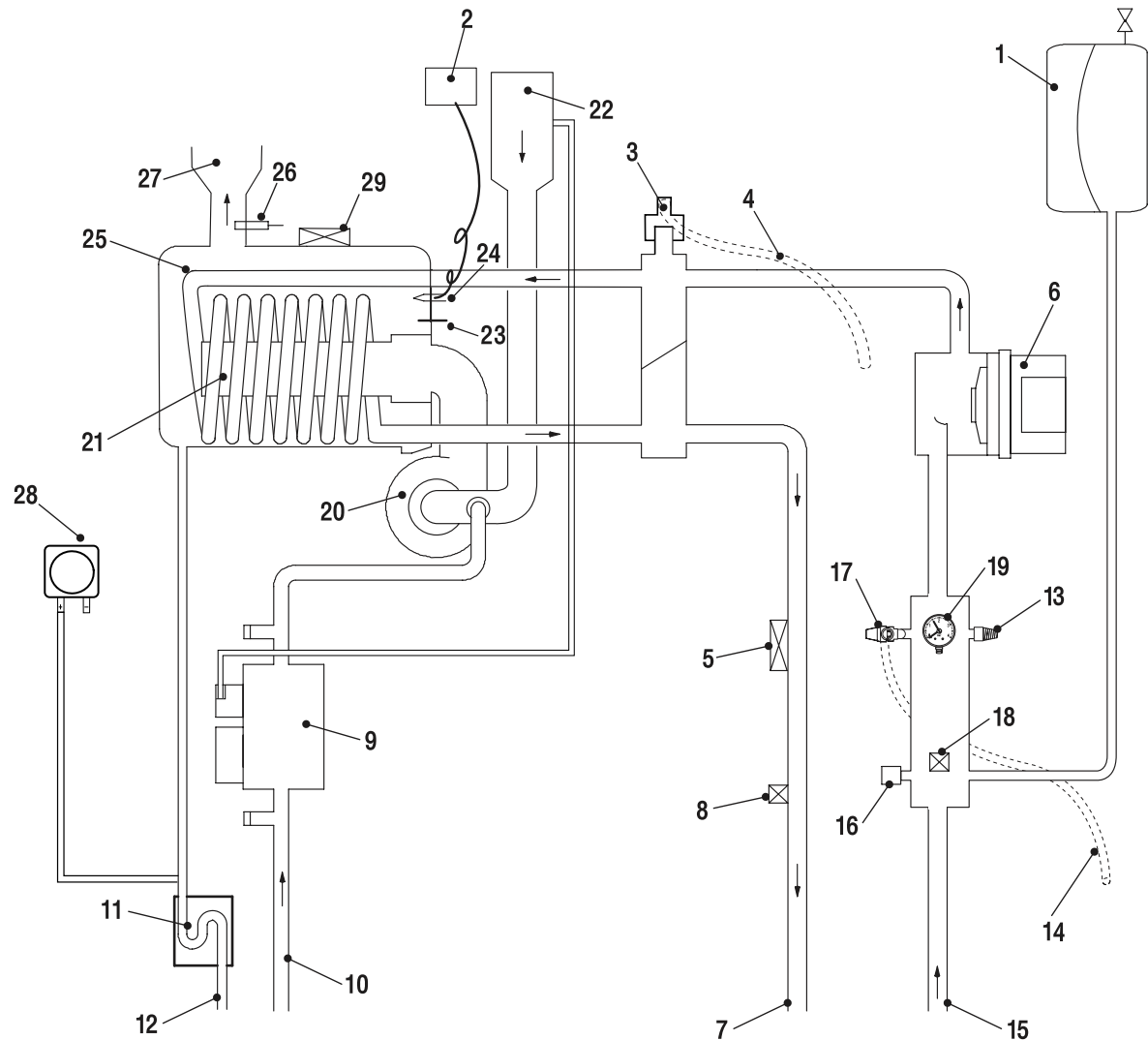

- | | |
|------------------------------------|---|
| 1 Expansion vessel (only \F model) | 17 Safety valve 4bar (only \F model) |
| 2 Remote activation control | 18 NTC heating return sensor |
| 3 Manual purge valve | 19 Pressure gauge |
| 4 Purge outlet | 20 Blower |
| 5 Safety thermostat | 21 Burner |
| 6 Modulating Pump (only \F model) | 22 Air intake duct complete with silencer |
| 7 Heating supply pipeline | 23 Flame detector electrode |
| 8 NTC heating supply sensor | 24 Ignition electrode |
| 9 Gas valve | 25 Primary condensing exchanger |
| 10 Gas inlet | 26 Flue sensor |
| 11 Condensate drain syphon | 27 Flue expulsion duct fitting |
| 12 Condensate drain hose | 28 Siphon Switch |
| 13 Boiler drain valve | 29 Thermal fuse |
| 14 Safety valve drain | |
| 15 Heating return pipeline | |
| 16 Pressure transducer | |

SYSTEM PUMP

MULTIPARVA 3.0 F boilers are equipped with a boiler pump with the specifications as outlined below.



WARNING

NEVER run the pump without water.

GENERAL

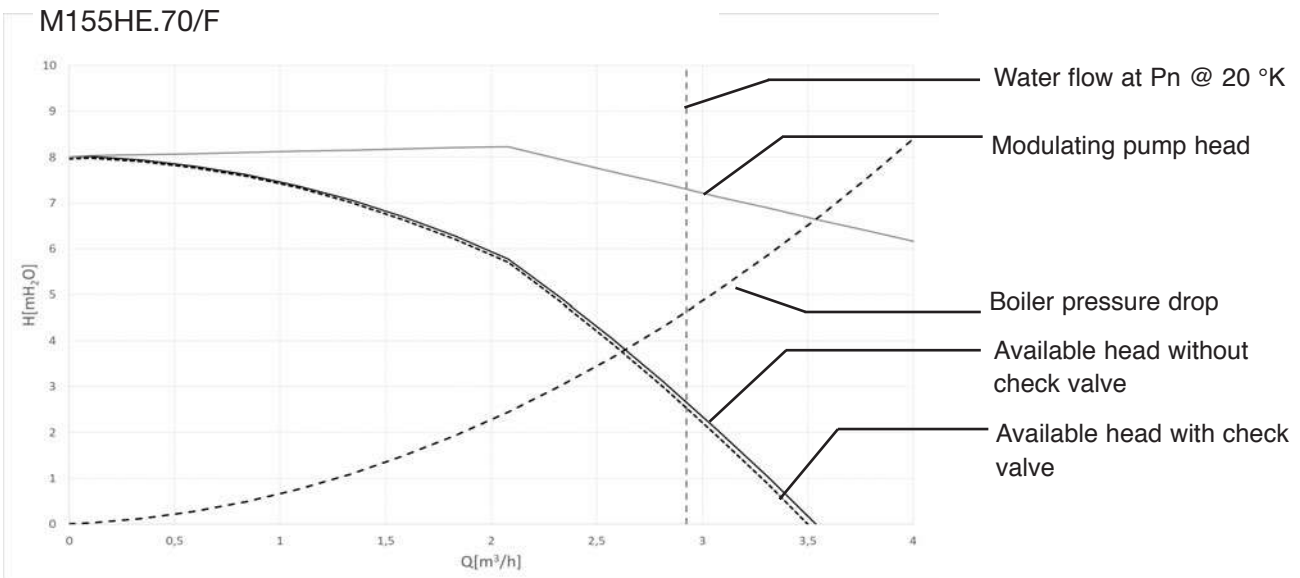
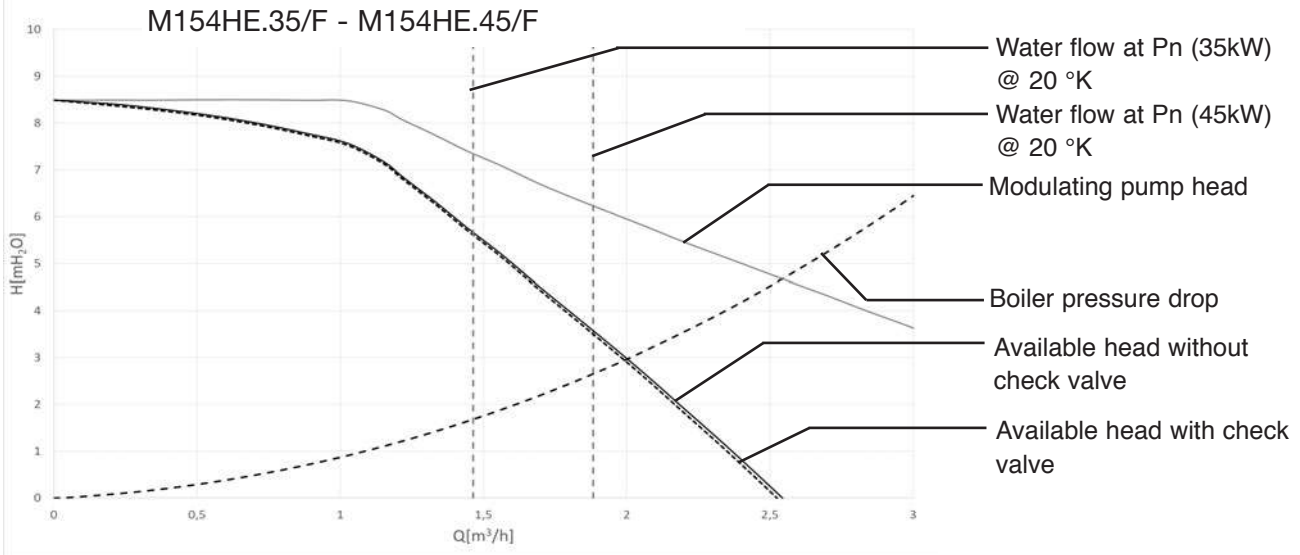

CONTROL PANEL

DSP

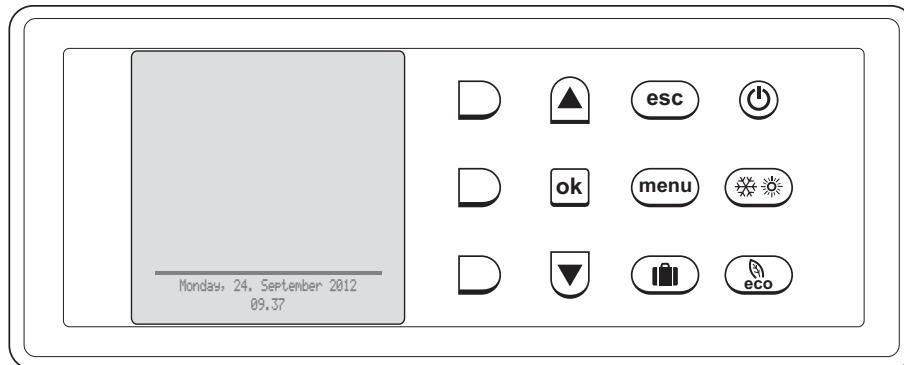





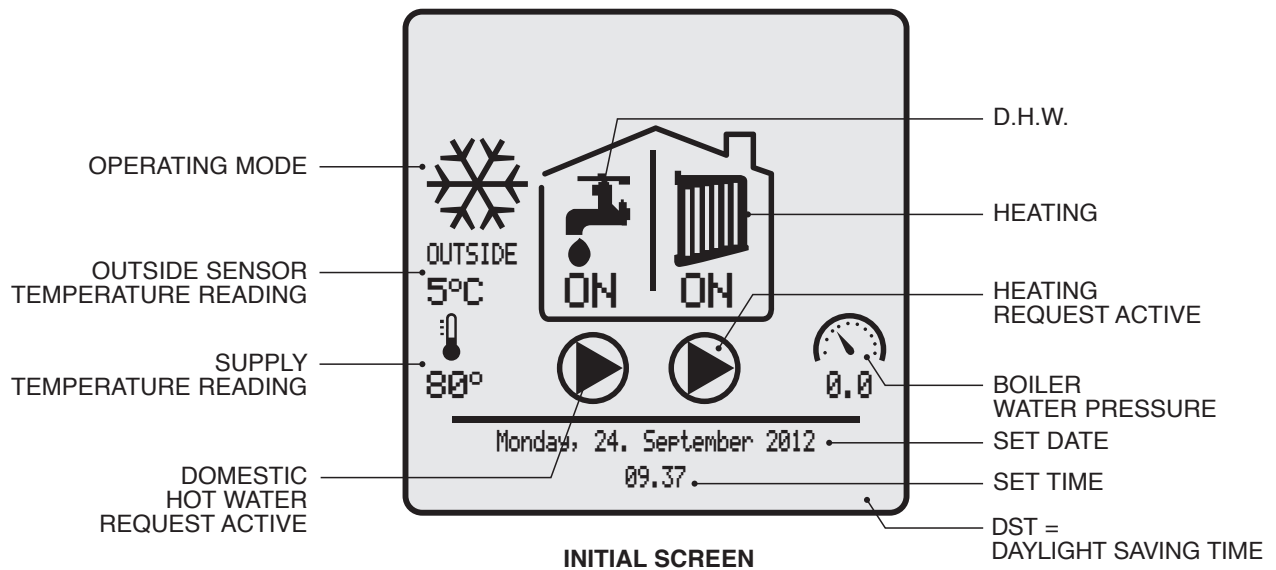

GENERAL



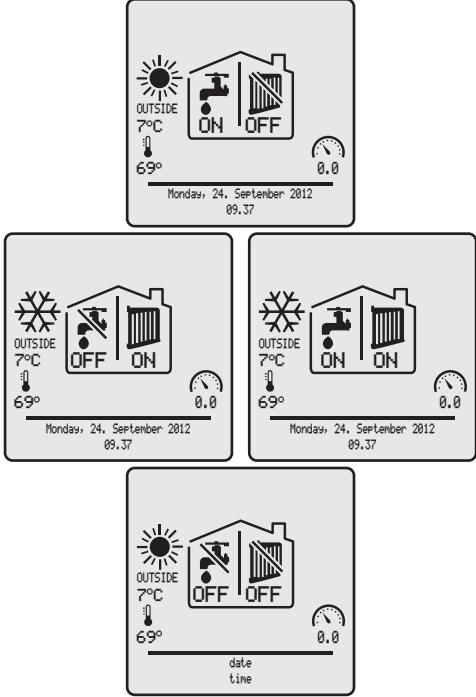

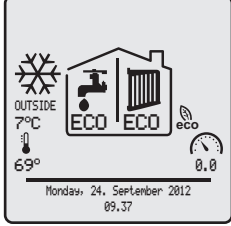

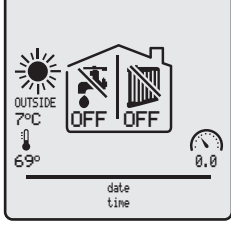

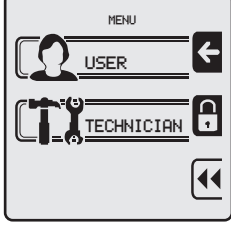





DESCRIPTION OF SYMBOLS ON DISPLAY

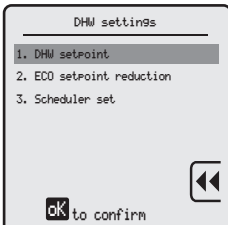
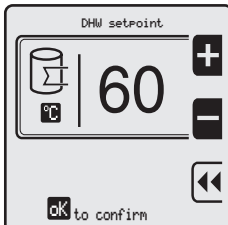

Key functions

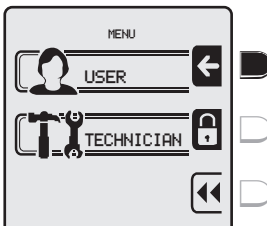
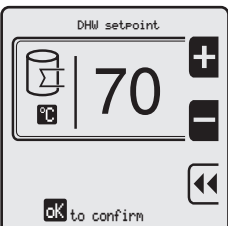
Key	Description of function	Display
	<p>ON/STAND-BY</p> <p>STAND-BY: This shuts down the appliance, inhibiting the use of DSP keys</p> <p>ON: This enables start-up of the appliance, enabling use of DSP keys</p>	

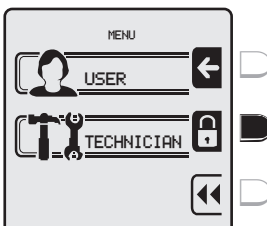
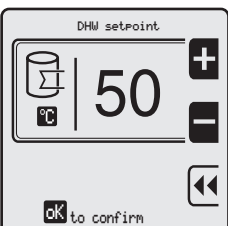
Key	Description of function	Display
	<p>OPERATING MODES</p> <p>SUMMER: DHW production only</p> <p>WINTER: heating only or heating and DHW</p> <p>NONE: no heating or DHW Anti-freeze or “Manual Test” function active</p>	
	<p>ECO - Manual</p> <p>This reduces, by the set value, the temperature of domestic water supply and heating water (energy saving mode)</p>	
	<p>ESC</p> <p>Interrupts the current action and returns to the initial screen</p>	
	<p>MENU</p> <p>Enables display of the page for menu selection (USER or TECHNICIAN)</p>	

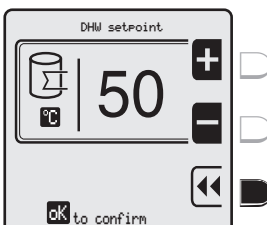
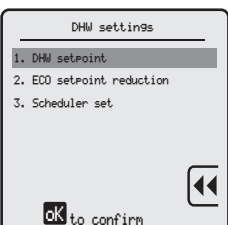
Key	Description of function	Display
	HOLIDAY This enables entry of the holiday dates (start/end) and values for the supply of domestic hot water and heating water during this period	 
 	UP Enables the user to scroll up through the lines on screen DOWN Enables the user to scroll down through the lines on screen Keep pressed to speed up the scrolling action.	 
	OK Enables: <ul style="list-style-type: none"> - access to the selected line of the menu or sub-menu - confirmation of a newly modified value 	 
	RED (at top) Enables: <ul style="list-style-type: none"> - access to the USER menu - increases to the value to be modified Keep pressed to speed up the action.	 
	RED (intermediate) Enables: <ul style="list-style-type: none"> - access to the TECHNICIAN menu - decreases to the value to be modified Keep pressed to speed up the action.	 
	RED (at bottom) Enables return to the selected line without saving/storing the modified data.	 

WIRING DIAGRAM

MULTIPARVA 3.0 F model

GENERAL

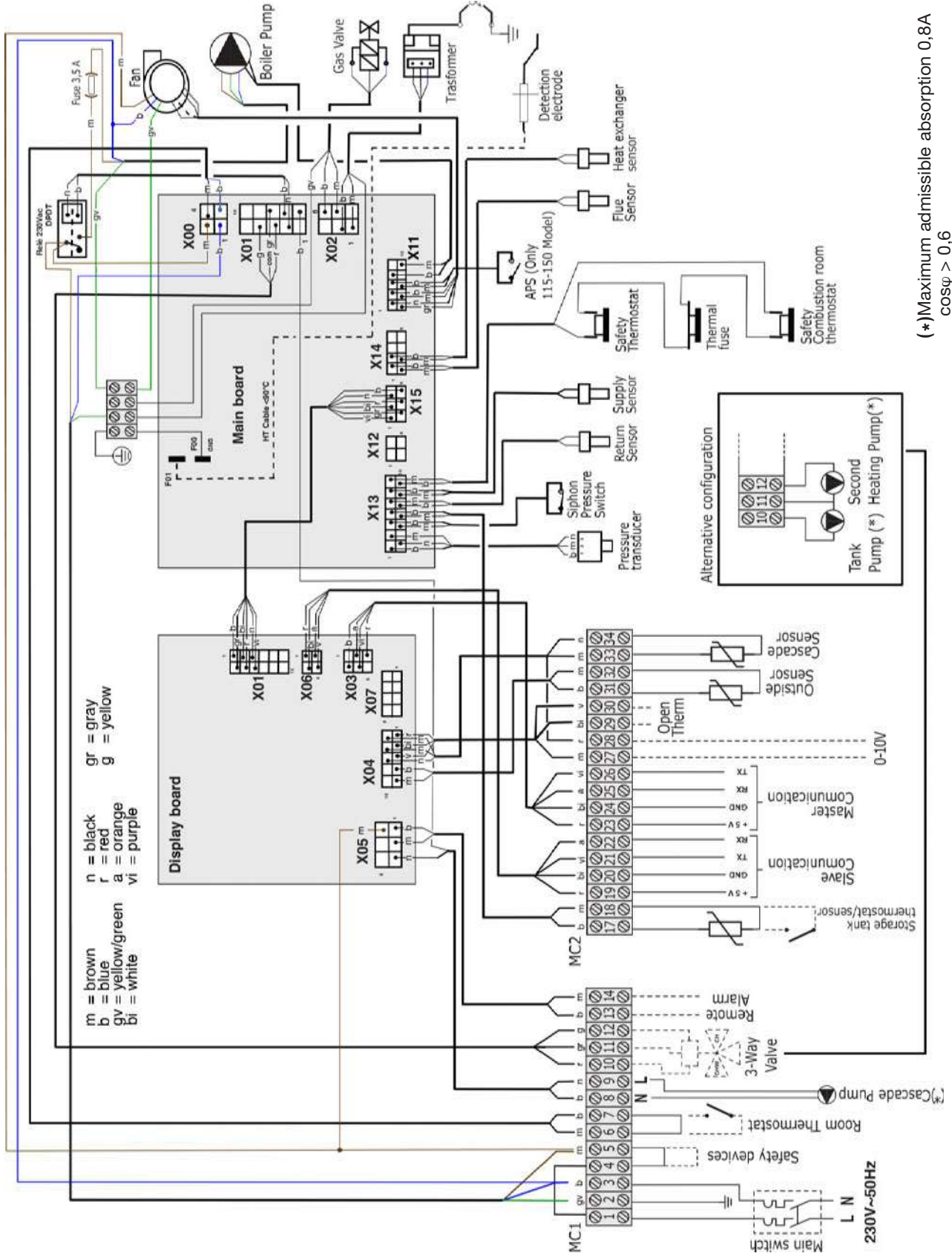

MULTIPARVA 3.0 N model

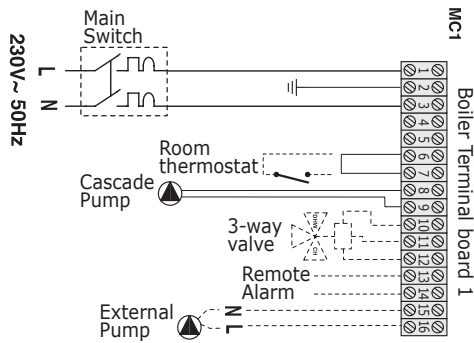

MULTIPARVA 3.0 N are models without water pump, but there is the possibility to control an external pump. In these models, the power supply of the pump is connected to the main terminal board.

The PWM signal is guaranteed by the free connector in the wiring.



The correct PWM connection is guaranteed only with compatible pumps approved by BIASI. On the contrary, the installer has the responsibility of the PWM connection with different pumps.

PRODUCT DELIVERY

MULTIPARVA 3.0 F appliances are supplied in a single pack protected with carton packaging and a wooden crate. The lower section of the boiler is fitted with a support bracket for the wall-mounting of the appliance.

The following material is supplied in a plastic envelope outside the packaging:

- Installation and maintenance manual
- User's manual
- Warranty certificate and adhesive labels with bar code
- Hydraulic test certificate
- Spare parts catalogue
- Control unit handbook.

WARNINGS

- Always use suitable personal protective equipment when removing packaging and handling the appliance.
- The manual is an integral part of the appliance and therefore it is recommended to read it before installing and operating the appliance. The manual should be stored with care for future consultation and possible transfer to another Owner or User.

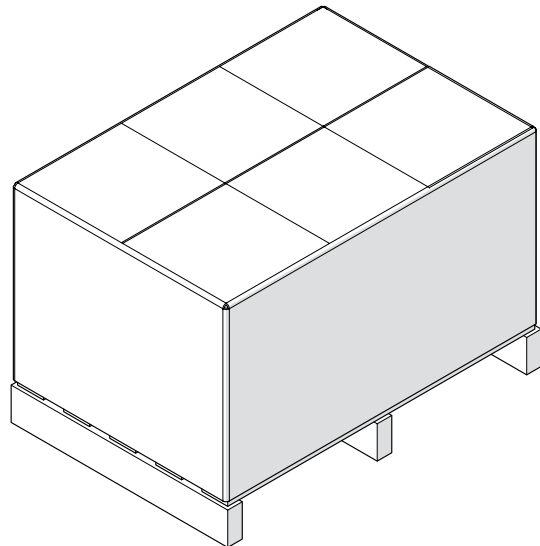

DIMENSIONS AND WEIGHT

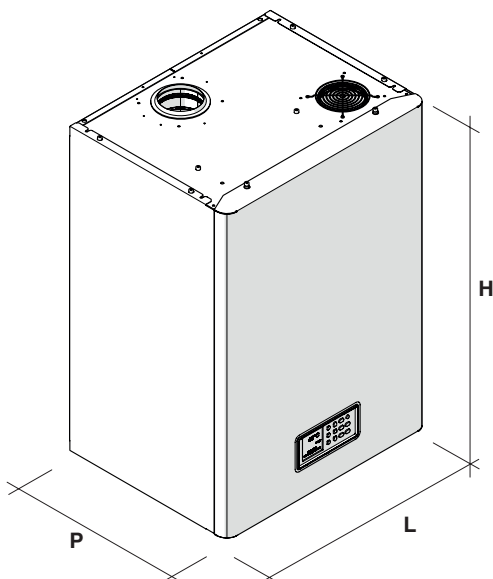

Dimensions and Weight	M154HE.35/F M154HE.45/F	M155HE.70/F	
L	600		mm
P	480		mm
H	840		mm
Weight	60	65	kg

HANDLING

After removing the packaging, the appliance can be handled manually by tilting it and lifting it from the points indicated in the figure.

⚠ Never use the boiler casing as a lifting point; always use “solid” parts such as the base or rear structure.

⚠ ALWAYS use suitable accident protection equipment.

⊘ It is strictly prohibited to dispose of packaging into the environment or leave in the reach of children as this constitutes a potential source of danger. It must therefore be disposed of in accordance with current legislation in the place of use.

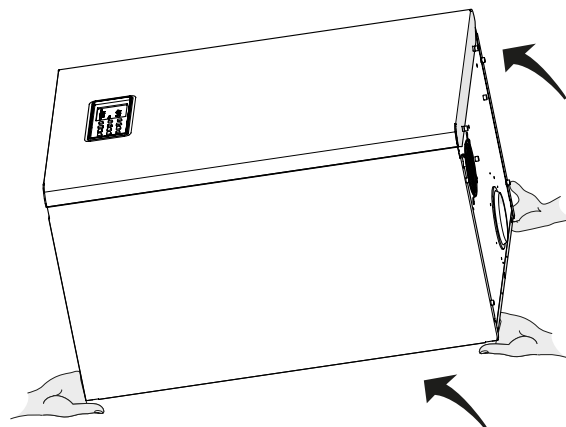

INSTALLATION ROOM

The installation room must always comply with current technical standards and legislation in the country of use. The room must be fitted with suitably sized ventilation outlets in the case of “TYPE B23P” installations. The installation room must exclusively be for this purpose and comply with current technical standards and legislation in the country of use.

MULTIPARVA 3.0 F appliances may also be installed outdoors, under a canopy, i.e. with adequate protection from atmospheric agents.

⚠ WARNINGS

- Take into account the clearances required for accessibility to the safety/adjustment devices and for maintenance purposes.

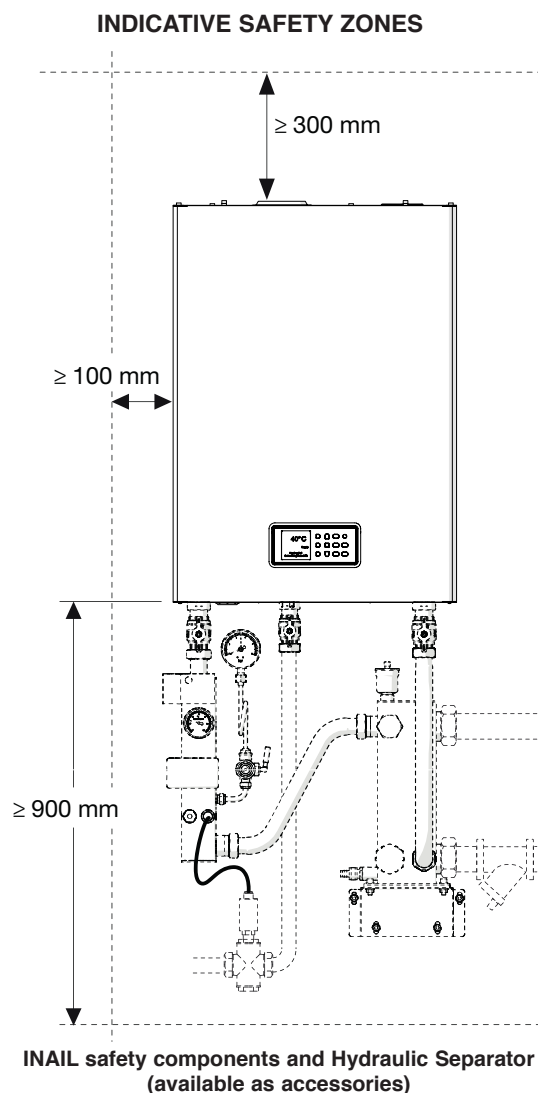

NEW INSTALLATIONS OR REPLACEMENTS OF OLDER APPLIANCES

When the appliance is installed on systems that are old or to be updated, ensure that:

- The flue duct, if re-used, is suitable for the new condensing boiler, and that it is calculated and constructed in compliance with current standards, as straight as possible, airtight, insulated and free of any obstructions or narrowed sections.
- The flue is fitted with an outlet for removal of condensate.
- The electrical system complies with the relevant standards and is set up by professionally qualified personnel.
- The fuel intake line and tank (if fitted) is produced according to the specific standards and is fitted with a gas meter.
- The expansion vessel ensures total absorption of fluid expansion in the system.
- The system is washed, removing all sludge and deposits and that all hydraulic seals are efficient.
- A supply water treatment/replenishment system is fitted, as described in the next chapter.
- **Efficient systems are fitted for the elimination of air and impurities up to 5 µm (e.g. Y filters, micro-impurity separators and micro air bubble separators).**
- If an automatic filling system is fitted, a litre counter is installed in order for a precise check on the entity of any leaks.
- Water must never be drained from the system during routine maintenance, even in apparently insignificant quantities. For example when cleaning filters, ensure that the system has specific shut-off valves for this purpose.



WARNINGS

The manufacturer declines all liability for possible damage caused by incorrect installation or design of the flue or constant replenishment of the boiler water.

WATER TREATMENT

Before installing the appliance, thoroughly clean all pipelines and heating elements.

PROPERTIES OF WATER TO BE USED WHEN FILLING THE SYSTEM

The following type of water must be used to fill the system:

pH : from 6,5 to 9
French degrees: from 5 to 15°f

If the system water also comes into contact with aluminium, a pH factor of less than 8.5 is required.

If the analysis of a sample of the water to be used for filling the system shows values other than those above, a suitable inhibitor must be used. This will prevent the formation of scale, which could impair correct operation of the boiler unit.

In the case of systems at low temperatures only, a product must be used to inhibit the spread of bacteria.

Water treatment in civil heating systems: see standard UNI 8065 of 1989.

REPAIRS AND PARTS REPLACED DUE TO THE FORMATION OF SCALE ARE NOT COVERED BY THE WARRANTY.

CAUTION: both on new systems or replacements, the system must be fitted with efficient systems that eliminate the air and impurities up to 5 µm (e.g. Y filters, micro impurity separators and micro air bubble separators).

WARNINGS

- Never soften water using the ion exchange principle.
- Never fill the system using distilled or demineralised water, as these cause serious corrosion of the heat exchanger. The system must be filled and replenished with softened water to reduce overall hardness. The water must also be treated to maintain the pH factor within the envisaged range, to avoid the risk of corrosion.
- On a register, note the quantity of filling water, top-up water, water quality readings and water treatment used.
- Install a meter to control the quantity of filling and top-up water.
- The conductivity of the untreated water in the system must NEVER exceed 600 $\mu\text{s}/\text{cm}$.
- If the system water is treated, strictly observe the instructions of the manufacturer of the product used, and ensure that conductivity NEVER exceeds 2000 $\mu\text{s}/\text{cm}$.
- **In the event of generator replacement, it is MANDATORY to wash the entire system.**

NOTE: If conductivity exceeds the values specified above, drain the system, flush it and fill with clean and treated tap water.

HYDRAULIC FITTINGS

The following section specifies the requirements of the boiler hydraulic fittings.

WARNINGS

- The boiler is delivered with a check valve as part of the standard supply. Ensure that the check valve is inserted in the return connection (RI) **only** in the case of cascade configurations.

Description	MULTIPARVA 3.0 F	
MI System supply	1"1/4 M	Ø
RI System return	1"1/4 M	Ø
Sd Condensate syphon drain	25	mm
Sv Safety valve drain	-	mm
SC Boiler drain	-	mm

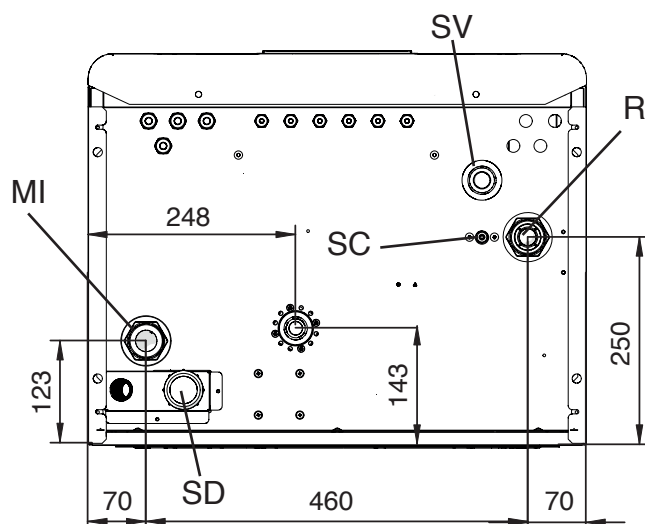
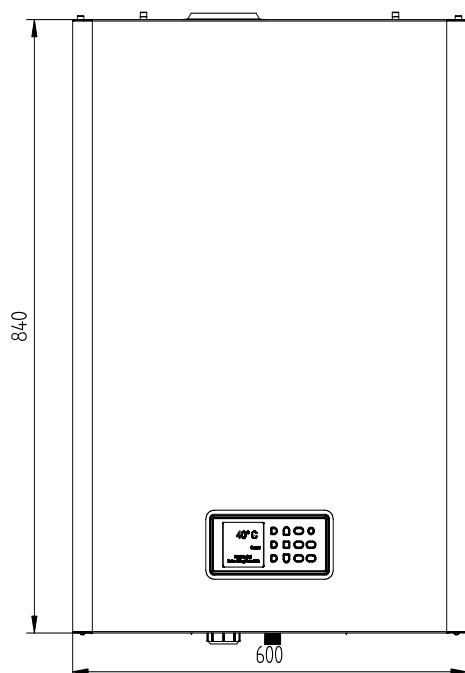

EXAMPLES OF OPERATING PRINCIPLE DIAGRAMS

MULTIPARVA 3.0 F

Management of a HIGH TEMPERATURE zone and a LOW TEMPERATURE zone

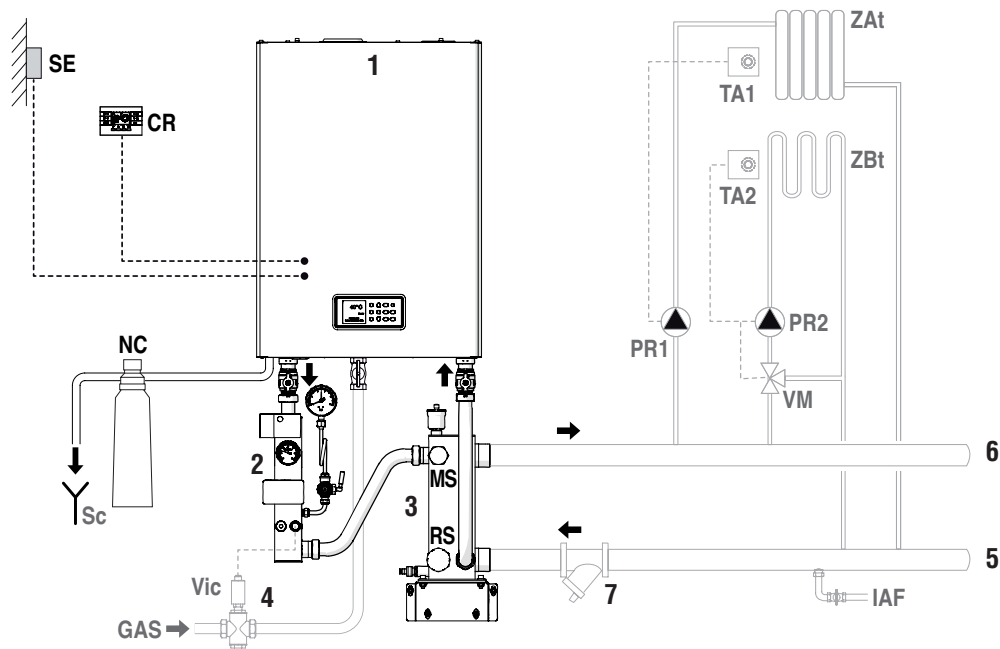

- 1 Boiler
- 2 INAIL safety module (*)
- 3 Hydraulic separator(*)
- 4 Fuel shut-off valve
- 5 System return manifold
- 6 System supply manifold
- 7 Screening filter

- SE OTC sensor (*)
- NC Condensate neutraliser (*)
- CR Remote control
- Sc Drain
- ZAt High temperature zone
- ZBt Low temperature zone
- TA1 room thermostat in high temperature zone
- TA2 room thermostat in low temperature zone
- PR1 High temperature system pump
- PR2 Low temperature system pump
- VM Low temperature system mixing valve
- Sc Fuel shut-off sensor
- GAS Fuel supply
- IAF Cold water inlet
- MS DHW delivery line (G 1" 1/4 M)
- RS Return DHW (yellow G 1" 1/2)

(*) Available as accessory.

MULTIPARVA 3.0 F

Management of a HIGH TEMPERATURE zone, a LOW TEMPERATURE zone and a remote STORAGE TANK

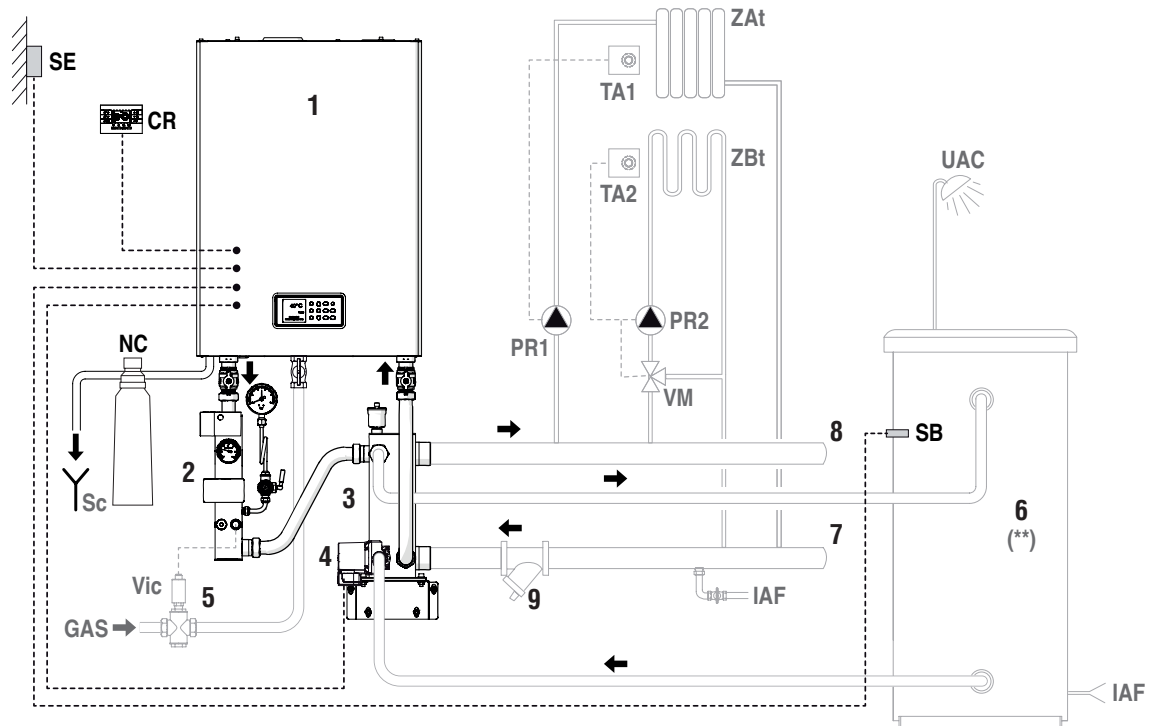

- 1 Boiler
- 2 INAIL safety module (*)
- 3 Hydraulic separator(*)
- 4 Pump (*)
- 5 Fuel shut-off valve
- 6 Remote storage tank (**) (managed directly by the boiler)
- 7 System return manifold
- 8 System supply manifold
- 9 Screening filter

- SE OTC sensor (*)
- NC Condensate neutraliser (*)
- CR Remote control
- SB Storage tank sensor (*)
- Sc Drain
- ZAt High temperature zone
- ZBt Low temperature zone
- TA1 Room thermostat in high temperature zone
- TA2 Room thermostat in low temperature zone
- PR1 High temperature system pump
- PR2 Low temperature system pump
- VM Low temperature system mixing valve

- Sic Fuel shut-off sensor
- GAS Fuel supply
- IAF Cold water inlet
- UAC Hot water outlet

(*) Available as accessory.

(**) In this configuration, the use of a storage tank is recommended with a suitable sized coil exchanger.

⚠ WARNINGS

- Fill the condensate drain syphon (2) to a sufficient level and route the condensate drain hose correctly. Envisage suitable condensate treatment systems.
- The safety valve drain must be connected to a suitable disposal system. The manufacturer is not responsible for possible flooding caused by intervention of the safety valve.
- Systems charged with anti-freeze require the compulsory use of water shut-off devices.
- The selection and installation of the system components is the task of the installer, who must observe all current legislation and professional technical practices.
- The expansion vessel of the heating circuit must ensure total absorption of the fluid expansion in the system.

ELECTRICAL CONNECTIONS

MULTIPARVA 3.0 F appliances require the connections shown below, which must be made by the installer or other professionally qualified personnel.

To access the boiler terminal boards:

- Remove the front panel of the casing
- Remove the four screws (1) and turn the control panel (2) to enable access to the boiler terminal board (MC2). Make connections to (MC2) inserting the cables in the relative strain relief cable glands (3) at the base of the boiler.
- Extract the sliding case and remove the board cover. Identify the boiler terminal board (MC1) and make the connections inserting the cables in the relative strain relief cable glands (4) at the base of the boiler.

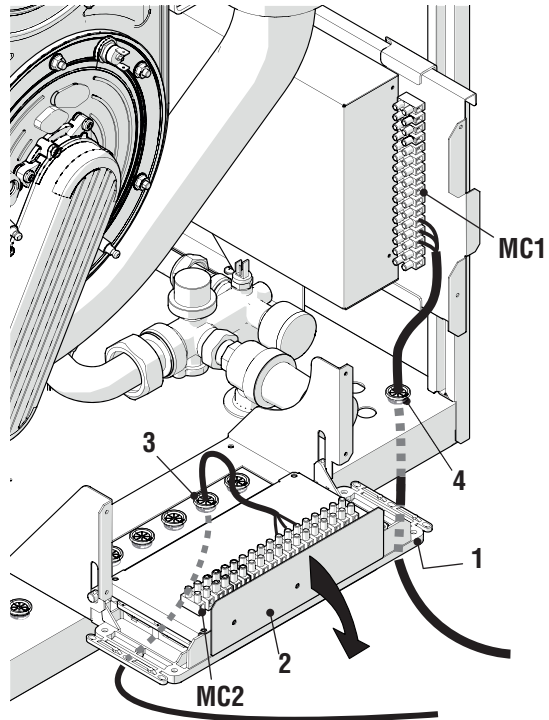

After making all connections, refit the front cover.

CONNECTION FOR OPERATION IN HEATING-ONLY MODE

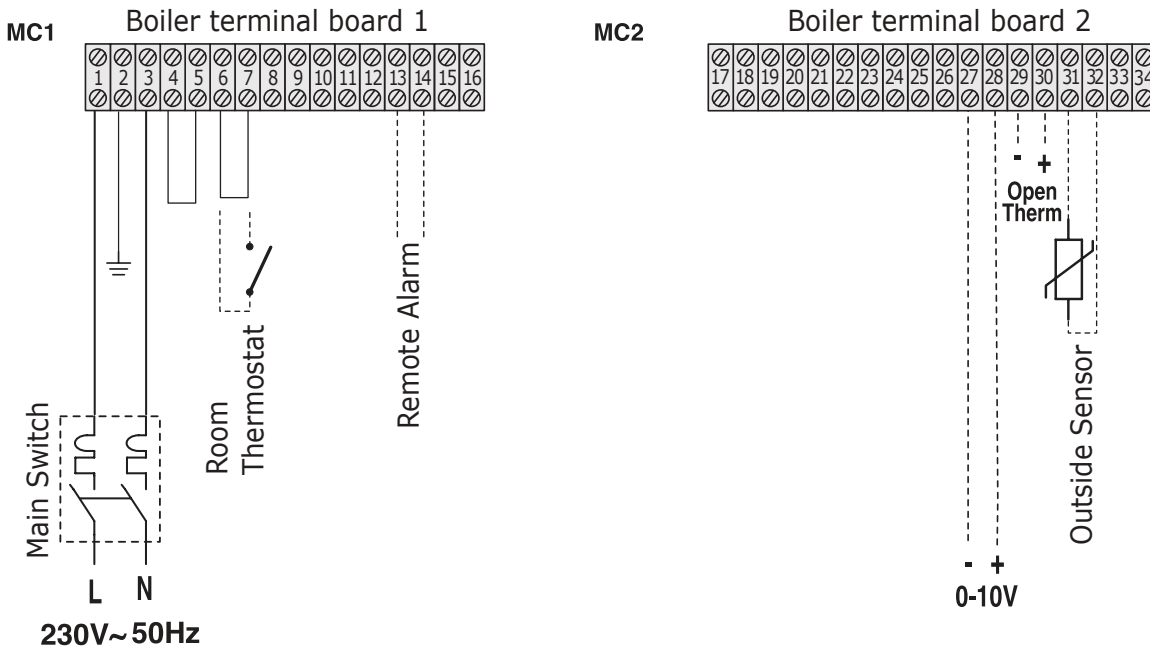

----- optional connections

CONNECTIONS FOR OPERATION IN HEATING AND DOMESTIC HOT WATER PRODUCTION MODE WITH MIX VALVE

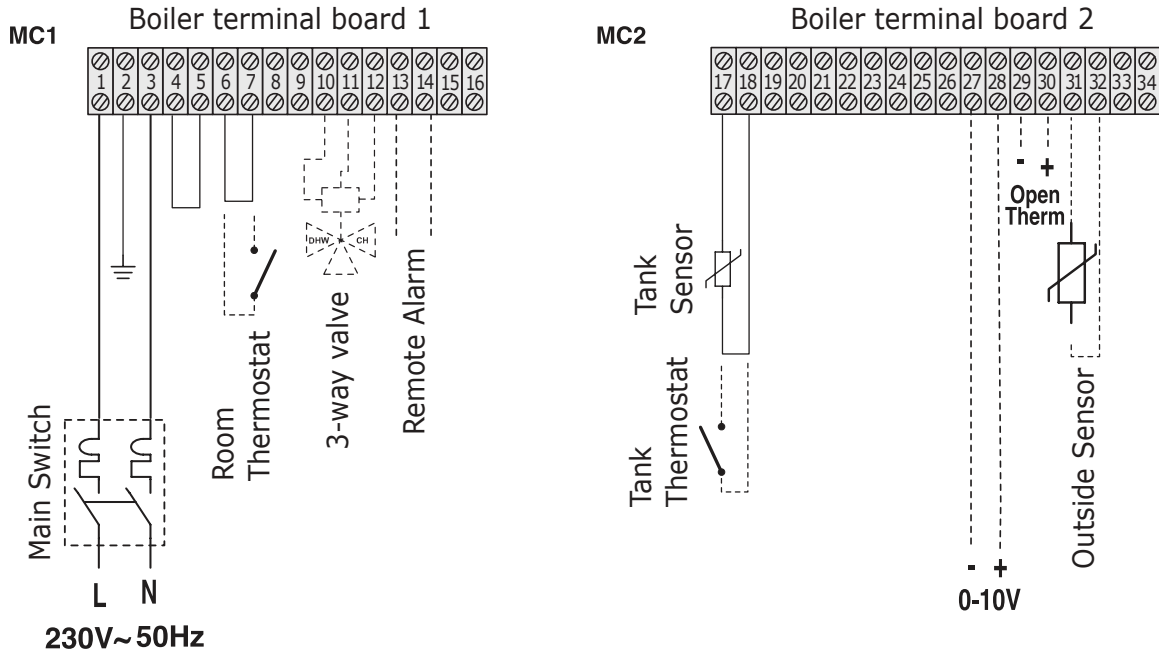

----- optional connections

CONNECTIONS FOR OPERATION IN HEATING AND DOMESTIC HOT WATER PRODUCTION MODE WITH STORAGE TANK PUMP

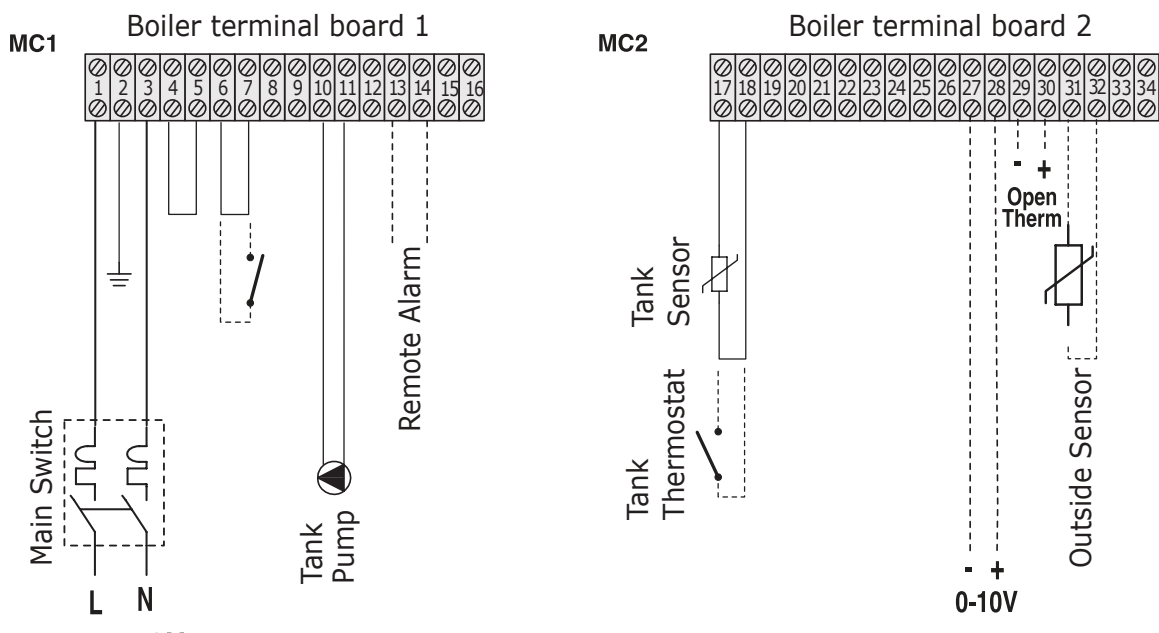

----- optional connections

WARNINGS

The following is compulsory:

- Use of an omnipolar thermal magnetic circuit breaker, line disconnecter, in compliance with EN standards.
- Observance of the connections L (Phase) - N (Neutral).
- Use of cable sections of AT LEAST 1 mm².
- Use of an earthing wire that is at least 2 cm longer than those of the L (Phase) - N (Neutral) connections.
- Reference to the wiring diagrams included in this manual for any type of electrical intervention.
- **Connections to an efficient earthing system (*)**.
- **NEVER** use water hoses for earthing the appliance.
- Great care to observe maximum absorption levels of the external circulation pumps (see "WIRING DIAGRAM" on page 14).

(*) The manufacturer declines all liability for any damage caused by failure to earth the appliance or specifications in the wiring diagrams.

N.B. The on-board fuse is 3.15A both for Phase and Neutral. The water pump fuse is 3,15A too.

REMOTE ALARM

The outputs of terminals 13-14 supply a voltage-free contact (max 230Vac - 0.8A) for the management of an alarm signal. This contact is activated each time an error/malfunction occurs on the boiler.

CONNECTION OF OUTSIDE SENSOR (OPTIONAL)

The outside sensor must be installed on the outside of the building, on a flat surface in a north/north-east position (the coolest side) and at a safe distance from the flues, doors, windows and areas exposed to direct sunlight.

To install, proceed as follows:

- Remove the cover.
- Fix the sensor to the wall using two plugs.
- Make the electrical connections.

NOTE:

- Minimum cable section: 1 mm².
- Maximum connection length: 50 m.
- Non-polarised connection terminals.
- Use shielded coaxial cables, with 2 wires and connect the sheath to earth (only boiler side).

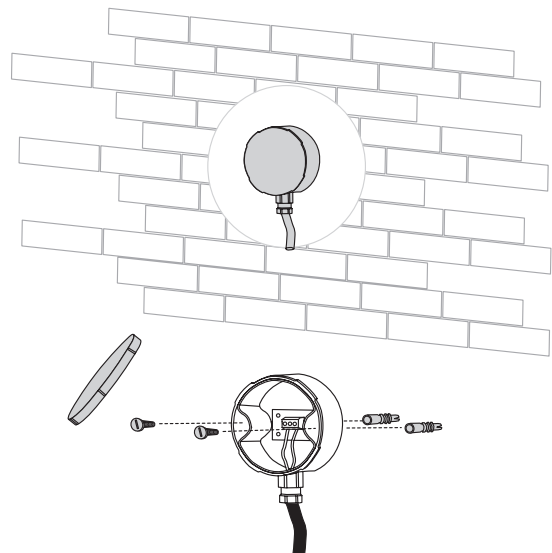

GAS CONNECTION

Connection of the **MULTIPARVA 3.0 F** appliance to the gas mains must comply with current installation standards.

Fittings	MULTIPARVA 3.0 F.	
GAS Gas supply	3/4"	Ø

Before making the connection, ensure that:

- the type of gas corresponds to the design specifications of the appliance
- the pipelines are thoroughly clean and free of processing residue.

The installation of the suitably sized filter is recommended.

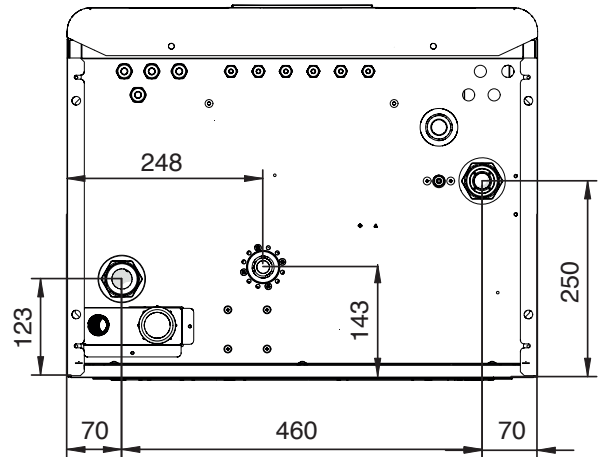

INSTALLATION

WARNINGS

- The gas supply system must be suitable for the capacity of the appliance and be equipped with all safety and control devices as envisaged by current standards.
- On completion of installation, check that all connections are sealed and secure.

FLUE EXHAUST AND EXTRACTION OF COMBUSTION AIR

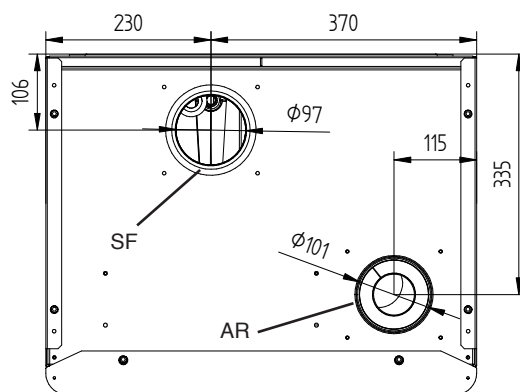

Dimensions		MULTIPARVA 3.0 F.	
SF	Flue exhaust	100	Ø mm
AR	Air intake	100	Ø mm

MULTIPARVA 3.0 F appliances are approved for installation types “B23P - C13 - C33 - C43 - C53 - C63 - C83 - C13X” and it is a MANDATORY requirement that they are equipped with an exhaust flue and combustion air extractor in compliance with the above types of installation.

Flue exhaust duct installation

The horizontal sections of the flue duct must be set at a gradient of approx. 1.5 degrees (25 mm per metre), and therefore the terminal must be positioned higher than the inlet on the boiler side.

NOTE: the terminal must be positioned higher than the inlet on the boiler side.

“TYPE B23P” installations

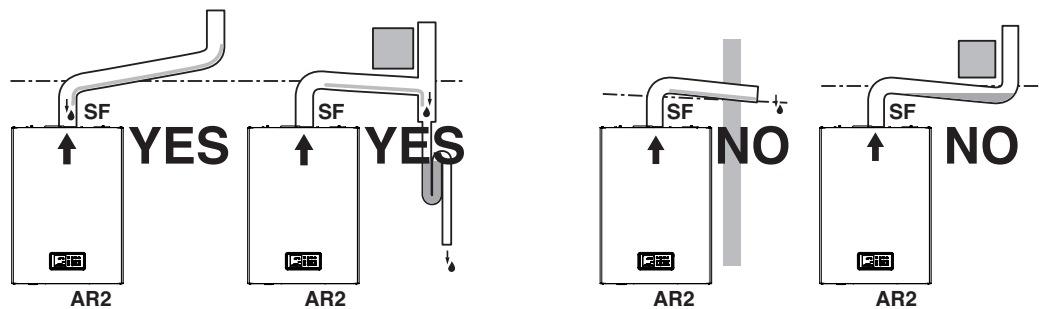

TYPE C63 FLUE EXHAUST DUCT AND AIR INTAKE DUCT NOT SUPPLIED BY MANUFACTURER

Type C63 installations must be same as Type C31 using ducts and terminals of a different manufacturer. ALL pipelines must comply in accordance with applicable legislation and the flue lines must be in materials compatible with condensation products.

When dimensioning the ducts, take into account the values of the residual head to the blower.

WARNINGS

- **MULTIPARVA 3.0 F** appliances are equipped with a flue exhaust sensor, which in the event of anomalous increases in flue temperatures, shuts down the appliance.
- **MULTIPARVA 3.0 F** appliances are equipped with a safety pressure switch which, in the event of an abnormal increase of the pressure inside the combustion chamber, promptly interrupts the operation of the appliance.
- Connect the condensate collection syphon to a clear water drain.
- Drain pipelines that are not insulated constitute a potential hazard.
- **The flue must be correctly sized for condensing boilers and must be fitted with a condensate drain. Inadequate or incorrectly sized flue ducts and condensate drains can cause problems with combustion parameters and excessive noise.**
- **IT IS STRICTLY PROHIBITED** to seal off or partially obstruct the ventilation apertures of the installation room and the appliance.

⚠ WARNINGS

- The pipeline materials must be suitable for use with this type of appliance.
- The straight pipe sections must be adequately supported and completely free of deformations.
- The joints must be airtight and self-locking.

FLUE TEST KIT

This kit enables simply and quick flue analysis.

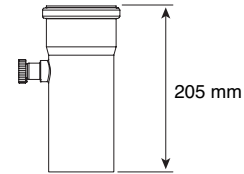

CONDENSATE REMOVAL

The condensate drain must comply with current local and/or national standards.

The condensate drain line must be tightly sealed, with dimensions suited to those of the syphon and without any throttled or reduced sections in gradient "i", which is recommended at $\geq 3\%$.

Install a neutralisation device, such as the model supplied separately on request.

Before commissioning the appliance, fill the syphon with water.

Plumb in manifolds on the condensate drain and flue exhaust

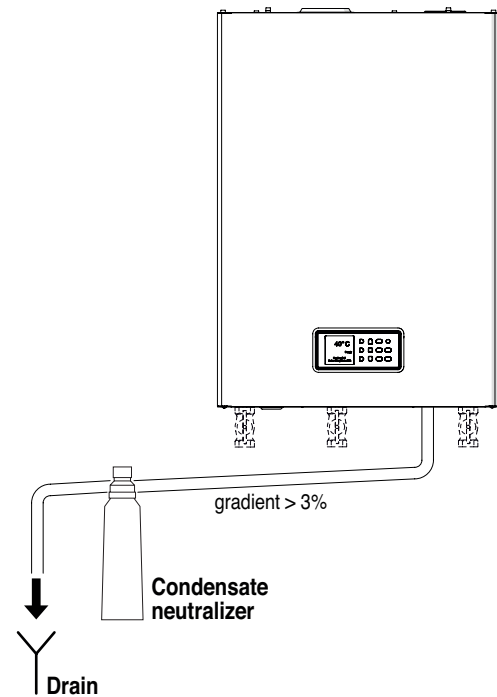

FILLING AND DRAINING

MULTIPARVA 3.0 F appliances are NOT fitted with a filler valve, and therefore a suitable filling system must be envisaged during installation at the most convenient point for the installer.

As a guideline, the figure illustrates a possible system filling unit connection point (CI).

WARNINGS

- The appliance is equipped with an manual purge valve (3) or purging the air from the system.

Before starting system filling or draining operations, set the main system switch (IG) to "OFF".

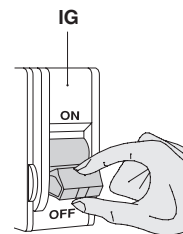
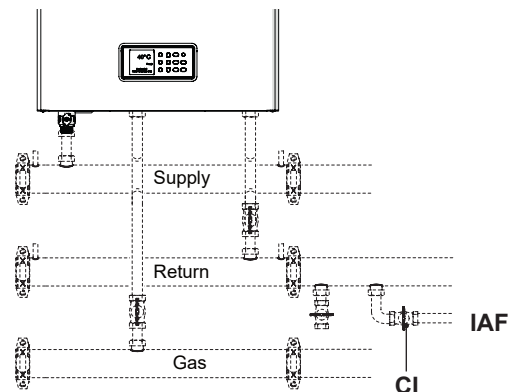

BOILER - SYSTEM FILLING

- In the case of cascade installations, ensure that the check valve supplied is inserted correctly in the system return connector (RI)
- Remove the front panel of the boiler
- Open the manual purge valve (3) in the front of the boiler and those envisaged at the highest point of the circuit.
- Ensure that the boiler drain valve (15) is closed
- Ensure that the pre-charge pressure of the expansion vessel(s) is correct
- Open the system filling valve (CI) and slowly charge until the pressure gauge (18) indicates a value, **in cool conditions, of approx. 2 bar**.
- Close the manual purge valve until there is no air.
- Close the system filling valve (CI).

N.B. Small deviations from readings between the pressure shown on the electronic display and that on the pressure gauge (18) on board the boiler are considered normal.

BOILER DRAINING

- Ensure that the system supply and return shut-off valves are closed
- Connect a rubber hose to the boiler drain valve (15) and then open the valve
- Open the manual purge valve (3)
- On completion of draining, close the drain valve (15) and the manual purge valve (3) on the boiler.

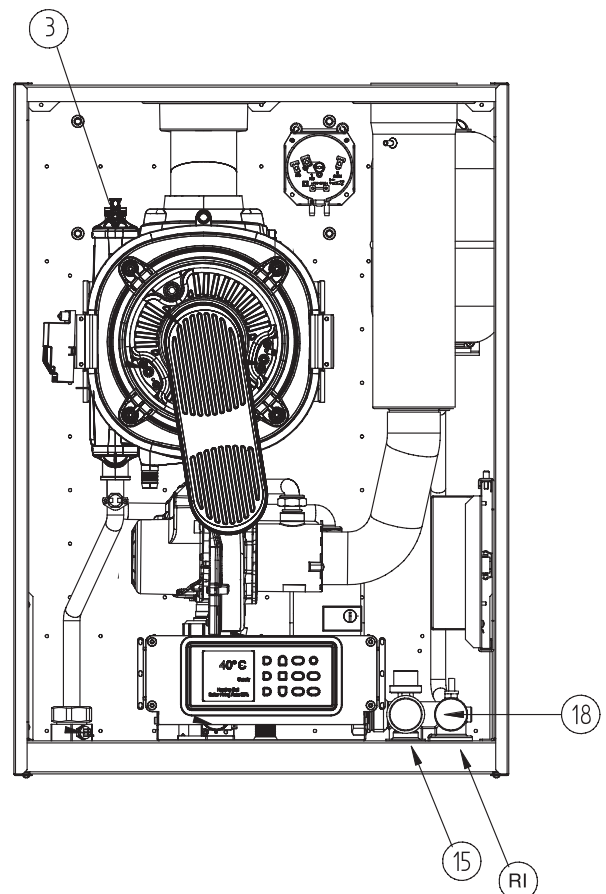

MENU NAVIGATION TREES AND PROCEDURES

Navigation procedure

The appliance is supplied in the configuration STAND-BY.
To scroll through the screen menus, use the keys shown in the diagram below.

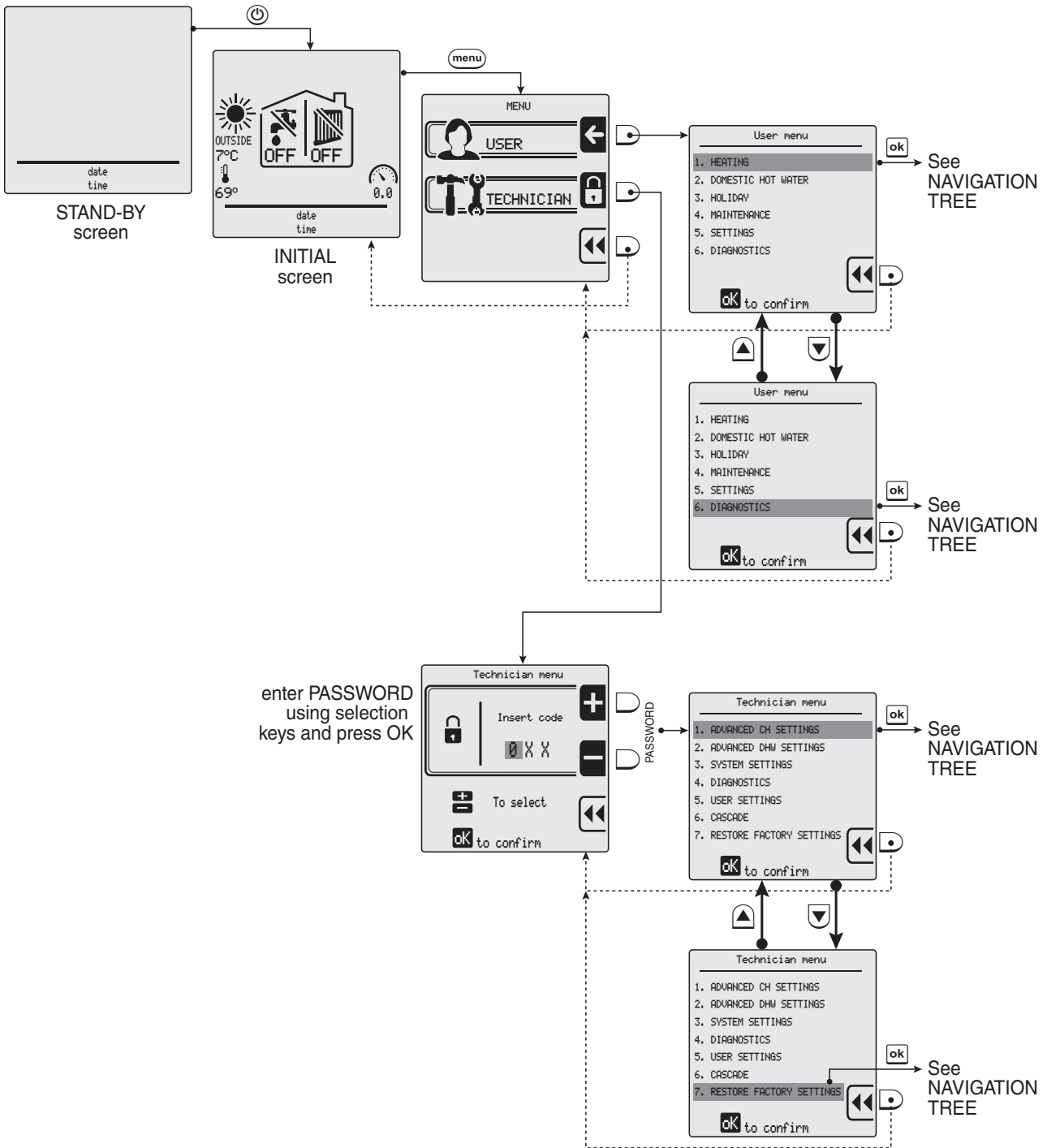

The following pages in this manual illustrate the user menu trees and the technician menu trees, together with the keys used for navigation.



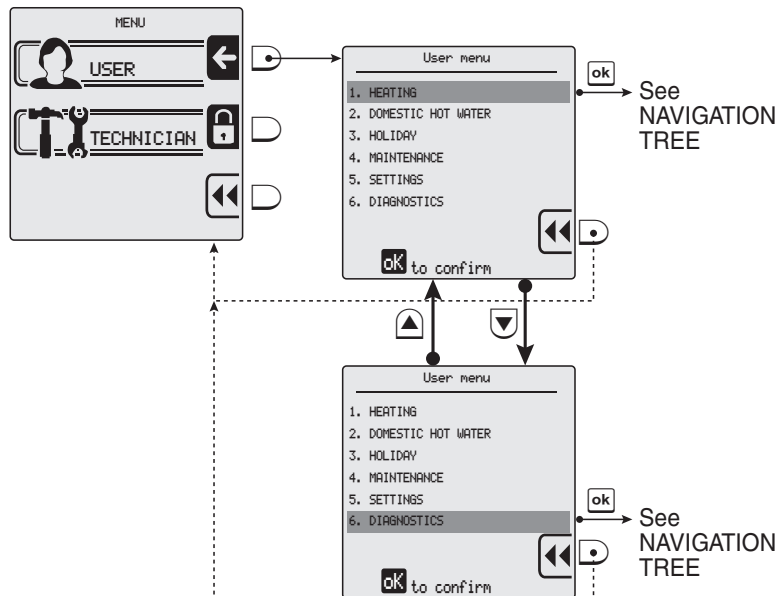

















User menu navigation TREE



USER MENU	Keys	Sub-menu	Keys	Lines	Keys	Factory settings	Field
1. HEATING	ok	1. DHW setpoint	ok	1. CH temperature/OTC set	ok	75°C	20 - max. absolute T. (*)
			▼	2. Outside temperature for CH off	ok	OFF	OFF / 7 - 30°C
	▼ ▲	2. ECO setpoint reduction	ok	---	---	50°C	0 - 50°C
			▼	3. Scheduler set	ok	1. Enable/disable scheduler	ok
▼	2. Scheduler settings	ok	Monday		week days		
2. DOMESTIC HOT WATER	ok	1. DHW setpoint	ok	---	---	80°C (**)	35 - 85°C
			▼	2. ECO setpoint reduction	ok	---	20°C
	▼ ▲	3. Scheduler set	ok	1. Enable/disable scheduler	ok	Enabled	Enabled/disabled
			▼	2. Scheduler settings	ok	Monday	week days
3. HOLIDAY	ok	1. CH holiday setpoint	ok	---	---	20°C	20 - max. absolute T. (*)
			▼ ▲	2. DHW holiday setpoint	ok	---	80°C (**)
4. MAINTENANCE	ok	1. Contact info	ok	---	---	read only	
			▼ ▲	2. Service due date	ok	---	---

(*) Maximum absolute temperature set at point "1.2.1" of the technician menu.

(**) - If "2.5 TYPE OF REQUEST" of the Technician menu = "Contact" then "Factory setting" = 80°C with "Field" = 30 ÷ 85°C.
 - If "2.5 TYPE OF REQUEST" of the Technician menu = "Sensor" then "Factory setting" = 60°C with "Field" = 10 ÷ 65°C..

USER MENU	Keys	Sub-menu	Keys	Lines	Keys	Factory settings	Field
5. SETTINGS		1. Select Language		English / Italiano		<i>Italiano</i>	<i>English/ Italiano</i>
 		2. Select Units		Fahrenheit / Celsius		<i>Celsius</i>	<i>Fahrenheit/ Celsius</i>
		3. Set date		--->		--->	<i>day / month / year</i>
		4. Set time		24 hour / 12 hour		---	<i>hours : minutes</i>
		5. Restore factory settings		--->		---	<i>OK to reset</i>
6. DIAGNOSTICS		1. Boiler information		<i>Read-only display of boiler status, temperature readings and blower rpm</i>			
		2. Lockout history		<i>read-only display of lockout/fault history</i>			

Key to the USER menu LINES

Ref. menu line	Line title	Meaning
1. HEATING		
1.1.1	CH temperature/OTC set	Entry of setpoint of supply temperature (heating)
1.1.2	Outside temperature for CH off	Entry of setpoint of outside temperature for automatic switchover to "Summer mode"
1.2	ECO setpoint reduction	Entry of value to reduce temperature on supply in "energy saving" mode (day or night time)
1.3.1	Enable/disable on board scheduler	Enable or Disable implementation of the "heating time bands" set for the various week days
1.3.2	Scheduler set	Settings of the "heating time bands" applied for the various week days
2. DOMESTIC HOT WATER		
2.1	DHW setpoint	Entry of the setpoint for DHW temperature
2.2	ECO setpoint reduction	Entry of value to reduce temperature of DHW in "energy saving" mode (day or night time)
2.3.1	Enable/disable on board scheduler	Enable or Disable implementation of the "DHW production time bands" set for the various week days
2.3.2	Scheduler set	Settings of the "DHW production time bands" applied for the various week days
3. HOLIDAY		
3.1	CH holiday setpoint	Entry of the setpoint for supply temperature during the holiday period.
3.2	Instant DHW setpoint	Entry of the setpoint for DHW during the holiday period.
4. MAINTENANCE		
4.1	Service information	Display of services contact phone number
4.2	Service due date	Display of date for next maintenance due

Ref. menu line	Line title	Meaning
5. SETTINGS		
5.1	Select Language	Selection of language (English or Italian)
5.2	Select Units	Selection of units of measurement (Celsius or Fahrenheit)
5.3	Set date	Entry or modification of current date. The transition from DST to the Solar time will take automatically.
5.4	Set time	Selection of 12 or 24 hour format - Entry or modification of current time
5.5	Restore factory settings	Restores factory settings
6. DIAGNOSTICS		
6.1	Boiler information	Display of boiler status and temperature readings To display, select the message, press ok and view the values, scrolling through items by means of the arrows ▼▲
6.2	Lockout history	Display of the error list.

Technician menu navigation TREE

Access to the technician menu requires entry of the PASSWORD "231".







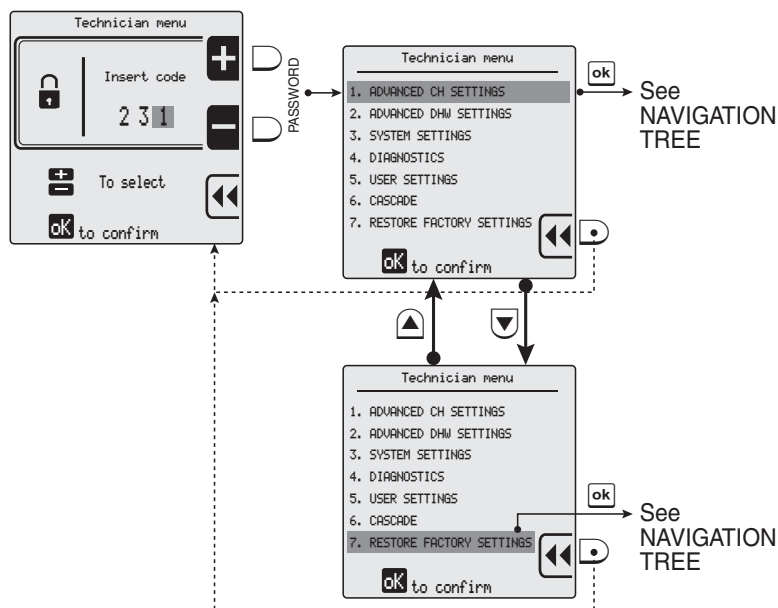









































The procedure is as follows:

- press **+** TWICE followed by **ok**
- press **+** THREE TIMES followed by **ok**
- press **+** ONCE followed by **ok**.

























For a maximum of 15 minutes, the system enables exit and subsequent re-entry to the technician menu without the need to enter the password. On elapse of this interval, entry of the password is required again to access the technician menu.



TECHNICIAN MENU	Keys	Sub-menu	Keys	Lines	Keys		Factory settings	Field	
1. ADVANCED CH SETTINGS	ok	1. CH power set	ok	1. Maximum power 100%	ok	---	100%	0 ÷ 100%	
			▼	2. Minimum power 0%	ok	---	0%	0 ÷ 100%	
	▼	2. CH temperatures	ok	1. ABS max temperature	ok	---	80°C	20 - 85°C	
			▼	2. CH maximum setpoint	ok	---	75°C	20 - 85°C	
			▼	3. CH minimum setpoint	ok	---	40°C	20 - 70°C	
			▼	4. CH setpoint hysteresis	ok	---	3°C	2 - 10°C	
			▼	5. CH slope rate	ok	---	10°C/min	0 ÷ 60°C/min	
	▼ ▲	3. OTC parameters	ok	1. Outside temp for max CH	ok	---	-10°C	-34 - 10°C	
			▼	2. Outside temp for min CH	ok	---	18°C	15 - 25°C	
			▼	3. Outside temp for CH off	ok	---	OFF	OFF/ 7 - 30°C	
			▼	4. OTC setpoint table	ok	---	read only		
			▼	5. OTC curve	ok	---	read only		
	▼	4. DHW pump settings	ok	1. DHW post pump time	ok	---	5'	1' ÷ 30'	
	▼	5. CH anticycling timer	ok	---	---	---	2'	0' ÷ 15'	
	▼	6. DHW request type	ok	Outside sensor / room therm. / 0-10V signal [%] / 0-10V signal [SP]	ok	---	Room thermostat	Outside sensor / room therm. / 0-10V signal [%] / 0-10V signal [SP]	
	2. ADVANCED DHW SETTINGS	ok	1. DHW power	ok	1. Maximum power 100%	ok	---	100%	0÷100%
				▼	2. Minimum power 0%	ok	---	0%	0÷100%
		▼ ▲	2. DHW temperature	ok	1. Storage DHW setpoint	ok	---	80°C	35÷85°C
				▼	2. Instant DHW setpoint	ok	---	60°C (*)	10÷65°C
				▼	3. DHW setpoint hysteresis	ok	---	3°C	2÷10°C
▼				4. DHW Offset	ok	---	20°C	0÷30°C	
▼		3. DHW pump settings	ok	1. DHW post pump time	ok	---	30s	Off/1÷180s	
▼		4. DHW priority	ok	1. DHW status	ok	---	Enabled	Enabled/ disabled	
			▼	2. DHW priority timeout	ok	---	Off	Off/1÷60min.	
▼		5. DHW request type	ok	---	---	---	Switch	Contact/ Sensor	

TECHNICIAN MENU	Keys	Sub-menu	Keys	Lines	Keys		Factory settings	Field	
3. SYSTEM SETTINGS	 	1. Boiler parameters		1. Ignition power		--->	51% (*)	0÷100%	
				2. Delay siphon check		--->	10s	0÷60s	
				3. Number of boiler pump		--->	Two pumps	Pump and 3-way valve/ Double pump	
				4. Pump speed max		--->	100%	15÷100%	
				5. Pump speed min		--->	30%	15÷100%	
				6. Anti-Legionella		1. Enable/disable Antilegionella	--->	Enabled/disabled	
						2. Antilegionella duration	15min	0÷255min	
						3. Antilegionella frequency	120hours	0÷254hours	
				7. Heat exchanger protection		--->	Enabled	Enabled/disabled	
				8. Heat exchanger delta		--->	10°C	5÷20°C	
			9. Modbus parameters		--->	0	0÷255		
			10. 3-way valve travel time		--->	10s	1÷255s		
			2. User interface settings		1. Language		--->	Italiano	English/ Italiano
					2. Select Units		--->	Celsius	Fahrenheit/ Celsius
					3. Set date		--->		Enter the date
					4. Set time		--->	24 hours	24 hours/ 12 hours
			3. Maintenance settings		1. Service information		--->		Enter tel. n°
	2. Service due date				--->		Enter date		
4. DIAGNOSTICS		1. Boiler information		---	---	---	-----		
 		2. Lockout history		---	---		-----		
		3. Manual Test		---	---		OFF	OFF / 0-100%	

(*) depending on the model



TECHNICIAN MENU	Keys	Sub-menu	Keys	Sub-menu	Keys	Lines	Keys	Factory settings	Field		
5. USER SETTINGS	 	ok 1. Heating	ok		ok	1. CH setpoint	ok	75°C	20 - 85°C		
				1. CH setpoint		2. Outside temperature for CH off	ok	OFF	OFF / 7 - 25°C		
			ok	2. ECO setpoint reduction	ok	---	---	50°C	0 - 50°C		
				3. Scheduler set	ok	1. Enable/disable on board scheduler	ok	Enabled	Enabled / disabled		
					2. Scheduler set	ok	Monday	week days			
				2. DHW settings	ok	1. DHW setpoint	ok	---	---	80°C	30 - 85°C
			2. ECO setpoint reduction		ok	---	---	20°C	0 - 50°C		
			3. Scheduler set		ok	1. Enable/disable on board scheduler	ok	Enabled	Enabled / disabled		
					2. Scheduler set	ok	Monday	week days			
			3. Holiday settings	ok	1. CH holiday setpoint	ok	---	---	20°C	20 - 85°C	
				2. DHW holiday setpoint	ok	---	---	30°C	30 - 85°C		
		6. CASCADE	 	ok 1. Cascade set	ok	1. Cascade switch delay	ok	---	---	60s	0÷255 s
						2. Cascade min power	ok	---	---	14%	0÷100%
						3. Single burner power	ok	---	---	depending on heating appliance	0÷2550kW
						4. Boiler for DHW	ok	---	---	0	0÷6
	5. PI loop period				ok	---	---	4s	1÷15 s		
	6. Burner water flow delay				ok	---	---	30s	0÷255 s		
	7. Different boiler size				ok	---	---	Disabled	Enabled / disabled		
	8. Cascade pump speed max.				ok	---	---	100%	15÷100%		
	9. Cascade pump speed min.				ok	---	---	30%	15÷100%		
	2. Cascade info			ok	---	---	---	---	Read only		
	3. Cascade autodetect	ok	---	---	---	---	----	----			

TECHNICIAN MENU	Keys	Sub-menu	Keys	Sub-menu	Keys	Lines	Keys	Factory settings	Field
7. RESTORE FACTORY SETTINGS	<input type="checkbox"/> ok	To restore the factory settings							
8. BOILER TYPE	<input type="checkbox"/> ok	1. Wall Hung Boiler 1	<input type="checkbox"/> ok	1. G20	<input type="checkbox"/> ok	1. 60kW	<input type="checkbox"/> ok	--->	Set
					<input type="checkbox"/> ▼	2. 100kW	<input type="checkbox"/> ok	--->	Set
					<input type="checkbox"/> ▼	3. 115kW	<input type="checkbox"/> ok	--->	Set
			<input type="checkbox"/> ▼	2. GPL/G30	<input type="checkbox"/> ok	1. 60kW	<input type="checkbox"/> ok	--->	Set
					<input type="checkbox"/> ▼	2. 100kW	<input type="checkbox"/> ok	--->	Set
					<input type="checkbox"/> ▼	3. 115kW	<input type="checkbox"/> ok	--->	Set
	<input type="checkbox"/> ▼	2. Wall Hung Boiler 2	<input type="checkbox"/> ok	1. G20	<input type="checkbox"/> ok	1. 35kW	<input type="checkbox"/> ok	--->	Set
					<input type="checkbox"/> ▼	2. 45kW	<input type="checkbox"/> ok	--->	Set
					<input type="checkbox"/> ▼	3. 70kW	<input type="checkbox"/> ok	--->	Set
					<input type="checkbox"/> ▼	2. 95kW	<input type="checkbox"/> ok	--->	Set
					<input type="checkbox"/> ▼	3. 110kW	<input type="checkbox"/> ok	--->	Set
					<input type="checkbox"/> ▼	2. 115kW	<input type="checkbox"/> ok	--->	Set
					<input type="checkbox"/> ▼	3. 150kW	<input type="checkbox"/> ok	--->	Set
			<input type="checkbox"/> ▼	2. G31	<input type="checkbox"/> ok	1. 35kW	<input type="checkbox"/> ok	--->	Set
					<input type="checkbox"/> ▼	2. 45kW	<input type="checkbox"/> ok	--->	Set
					<input type="checkbox"/> ▼	3. 70kW	<input type="checkbox"/> ok	--->	Set
					<input type="checkbox"/> ▼	2. 95kW	<input type="checkbox"/> ok	--->	Set
					<input type="checkbox"/> ▼	3. 110kW	<input type="checkbox"/> ok	--->	Set
					<input type="checkbox"/> ▼	2. 115kW	<input type="checkbox"/> ok	--->	Set
					<input type="checkbox"/> ▼	3. 150kW	<input type="checkbox"/> ok	--->	Set
	<input type="checkbox"/> ▼	3. Floor standing boiler 1/H	<input type="checkbox"/> ok	1. G20	<input type="checkbox"/> ok	1. 115kW	<input type="checkbox"/> ok	--->	Set
					<input type="checkbox"/> ▼	2. 150kW	<input type="checkbox"/> ok	--->	Set
					<input type="checkbox"/> ▼	3. 200kW	<input type="checkbox"/> ok	--->	Set
					<input type="checkbox"/> ▼	4. 240kW	<input type="checkbox"/> ok	--->	Set
					<input type="checkbox"/> ▼	5. 280kW	<input type="checkbox"/> ok	--->	Set
	<input type="checkbox"/> ▼	4. Floor standing boiler 2	<input type="checkbox"/> ok	1. G20	<input type="checkbox"/> ok	1. 340kW	<input type="checkbox"/> ok	--->	Set
					<input type="checkbox"/> ▼	2. 410kW	<input type="checkbox"/> ok	--->	Set
					<input type="checkbox"/> ▼	3. 480kW	<input type="checkbox"/> ok	--->	Set
<input type="checkbox"/> ▼					4. 550kW	<input type="checkbox"/> ok	--->	Set	
<input type="checkbox"/> ▼					5. 620kW	<input type="checkbox"/> ok	--->	Set	

INSTALLATION

KEY TO TECHNICIAN MENU

Ref. menu line	Line title	Meaning
1. ADVANCED CH SETTINGS		
1.1.1.	Maximum power	Entry of maximum applicable power
1.1.2.	Minimum power	Entry of minimum applicable power
1.2.1	ABS max temperature	Setting of maximum admissible appliance supply temperature
1.2.2	CH maximum setpoint	Setting of maximum supply temperature, corresponding to minimum outside temperature
1.2.3	CH minimum setpoint	Setting of minimum supply temperature, corresponding to maximum outside temperature
1.2.4	CH setpoint hysteresis	Value in °C, over which the maximum set temperature, before burner shut-off
1.2.5	CH slope rate	Value in °C/min. This parameter sets the increment value of the temperature per minute.
1.3.1	Outside temp. for max CH	Setting of minimum outside temperature, corresponding to the maximum supply temperature
1.3.2	Outside temp. for min CH	Setting of maximum outside temperature, corresponding to the minimum supply temperature
1.3.3	Outside temperature heating OFF	Setting of outside temperature for automatic switchover to "Summer mode"
1.3.4	Outside temperature setpoint table	Display of corresponding values of outside and supply temperatures, according to the set climatic curve
1.3.5	OTC curve	Display of set climatic curve graph
1.4.1	Post-pump time	Post-pump time setting
1.5	CH anticycling timer	Time interval during which burner ignition requests are ignored
1.6	CH request type	Selection of device used: Outside sensor, room thermostat, 0-10V signal [%] (power), 0-10V signal [SP] (temperature)
2. ADVANCED DHW SETTINGS		
2.1.1	Maximum power	Entry of maximum applicable power
2.1.2	Minimum power	Entry of minimum applicable power
2.2.1	Storage DHW setpoint	Water temperature of primary circuit for filling the storage tank (with tank thermostat fitted)
2.2.2	Instant DHW setpoint	DHW temperature (with tank sensor fitted)
2.2.3	DHW setpoint hysteresis	Value below the setpoint entered in the parameter 2.2.2 , which activates a DHW request in the boiler
2.2.4	DHW Offset	Increase value of the primary circuit water temperature compared to the setpoint imposed in the parameter 2.2.2, if a DHW sensor type is used.
2.3.1	Post-pump time	Post-pump time setting
2.4.1	DHW status	Enables/Disables priority of DHW over heating
2.4.2	DHW priority timeout	Entry of time after which DHW priority elapses (heating, if present, is served for the same time interval as that of DHW)
2.5	DHW request type	Selection of device used: Sensor (Probe) or Contact (Thermostat)

Ref. menu line	Line title	Meaning
3. SYSTEM SETTINGS		
3.1.1	Ignition power	Burner ignition power
3.1.2	Delay siphon check	Entry of delay before syphon pressure switch fault signal (not present)
3.1.3	Number of boiler pumps	Selection of 3-way valve and double heating pump
3.1.4	Pump speed max	Maximum boiler pump speed (primary)
3.1.5	Pump speed min	Minimum boiler pump speed (primary)
3.1.6	Antilegionella	Enables/Disables Anti-legionella function
3.1.6.1	Enable/disable Antilegionella	Enables/Disables Anti-legionella function
3.1.6.2	Antilegionella duration	Set the duration of the Antilegionella
3.1.6.3	Antilegionella frequency	Set of the frequency with which to perform the antilegionella (time expressed in hours between one antilegionella and the next one).
3.1.7	Heat exchanger protection	Enables/Disables protection with heat exchanger sensor
3.1.8	Heat exchanger delta	Entry of increment from supply temp., over which the heat exchanger temp. generates an error
3.1.9	Modbus parameters	Changes address of the display on the bus
3.1.10	3-way valve travel time	Enables modification to the stroke time of the 3-way valve for DHW if/when present.
3.2.1	Select Language	Selection of language (English or Italian)
3.2.2	Select Units	Selection of units of measurement (Celsius or Fahrenheit)
3.2.3	Set date	Entry or modification of current date
3.2.4	Set time	Selection of 12 or 24 hour format - Entry or modification of current time
3.3.1	Service information	Entry of telephone number for Technical Services
3.3.2	Set maintenance date	Entry of date for next maintenance
4. DIAGNOSTICS		
4.1	Boiler information	Display of boiler status and temperature readings To display, select the message, press  and view the values, scrolling through items by means of the arrows  
4.2	Lockout history	Display of the error list.
4.3	Manual test	Override of a heating cycle, with settable power, for a maximum duration of 15 minutes
5. USER SETTINGS		
5.1	Heating	See USER menu - 1. HEATING
5.2	DHW settings	See USER menu - 2. DOMESTIC HOT WATER
5.3	Holiday settings	See USER menu - 3. HOLIDAY

Ref. menu line	Line title	Meaning
6. CASCADE		
6.1.1	Cascade switch delay	Interval between ignition of different boilers
6.1.2	Cascade min power	Minimum available power in cascade
6.1.3	Single burner power	Maximum power of single burner
6.1.4	Boiler for DHW	Number of boilers also used for DHW
6.1.5	PI loop period	Time interval for recalculating power requirements
6.1.6	Burner water flow delay	Delay of response of control algorithm according to hydraulic structure. In the case of cascade configurations with disconnect, it is possible to balance the time in which a temperature variation, read by the cascade sensor, is effectively received by the control board.
6.1.7	Different boiler size	Enables/Disables algorithm-based control of cascade configurations of boilers with different outputs (e.g. in the presence of a low power generator dedicated to DHW production). In the case of combining several generators of the same output, this algorithm does not need to be enabled.
6.1.8	Cascade pump speed max	Setting of maximum admissible speed for cascade pumps
6.1.9	Cascade pump speed min	Setting of minimum admissible speed for cascade pumps
6.2	Cascade info	Display of information on the cascade configuration
6.3	Cascade autodetect	Start of cascade auto-configuration process.
7. RESTORE FACTORY SETTINGS		Restores factory settings
8. BOILER TYPE		
8.1	Wall Hung Boiler 1	Do not use
8.1	Wall Hung Boiler 2	Setting of type of boiler as "Wall-hung" "MULTIPARVA 3.0 F" and selection of output model Change to type of gas used
8.2	Floor standing boiler 1/H	Setting of type of boiler as "Floor-standing" (from 115 kW to 280 kW) and selection of output model Change to type of gas used
8.3	Floor standing boiler 2	Setting of type of boiler as "Floor-standing" (from 340 kW to 620 kW) and selection of output model Change to type of gas used

INITIAL COMMISSIONING

PRELIMINARY PROCEDURES

MULTIPARVA 3.0 F leave the factory:

- set up for operation with G20 (natural gas), but with the option of operating with LPG (G30-Butane / G31 - Propane) using the proper gas change kit;
- with unit DSP in stand-by;
- in the “none” operating mode; both heating and DHW requests are disabled. This prevents the boiler from starting when powered up, even when there is a heating request;
- without the check valve fitted.

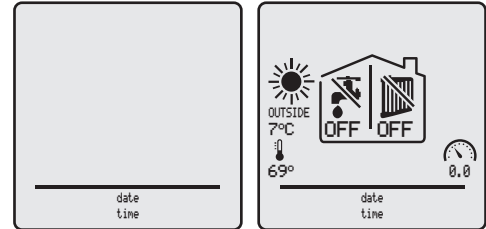

Before commissioning the appliance, it is essential to establish which type of gas is to be used. If this is LPG, the setting of the type of gas must be changed as described in the paragraph "GAS CHANGE" on page 45.

Following this, ensure that:

- all fuel shut-off valves and water valves are open
- the mains gas pressure is sufficient and that the pipelines have been purged
- the hydraulic circuit pressure, in cool conditions, is greater than 2 bar and no air is present in the circuit (purging completed)
- the expansion vessel is fitted, correctly sized and pre-charged
- all electrical connections have been made correctly
- the flue exhaust ducts and fuel air intake points (if present) comply with specifications/requirements
- the check valve is fitted and the relative data plate specifications are compatible with the maximum operating pressure of 6 bar
- the syphon is filled and the condensate drain line is routed correctly.

WARNINGS

- Before to power the boiler ensure that:
 - no ice has formed inside the boiler before connecting and powering it up.
- Before starting the boiler ensure that:
 - there is no obstruction inside flue pipes and air intake.
- After starting the boiler make sure that:
 - the gas pressure is not less than 18 mbar (G20) and 25 mbar (G31);
 - the fan speed is correct.
 - The CO₂ values are within + -0.1% of CO₂ compared to the values indicated. If not, adjust appropriately following the instructions given in the paragraph "GAS CHANGE" on page 45.

INITIAL COMMISSIONING

- Power up the boiler from the electrical mains by setting the main system switch (IG) to “ON”.





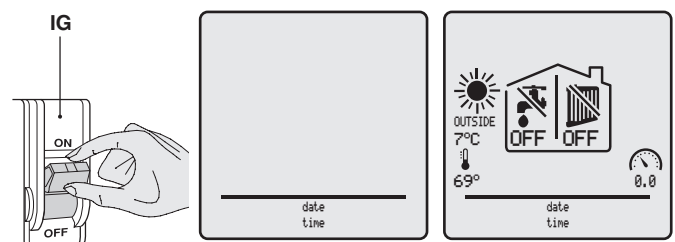







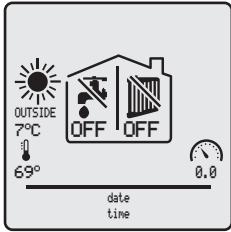
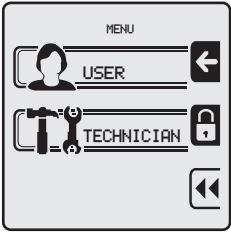



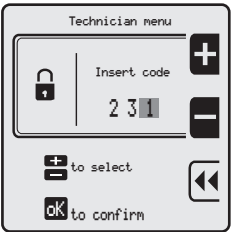

- The display returns to the stand-by screen.



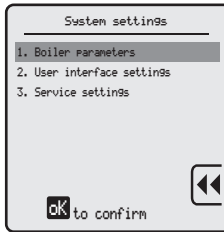

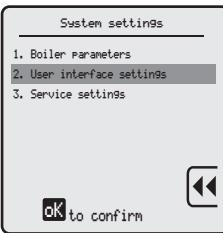
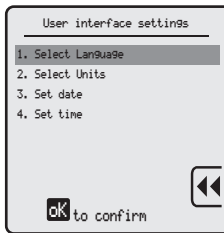



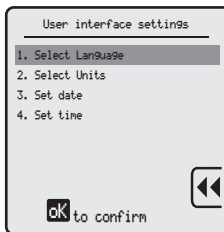



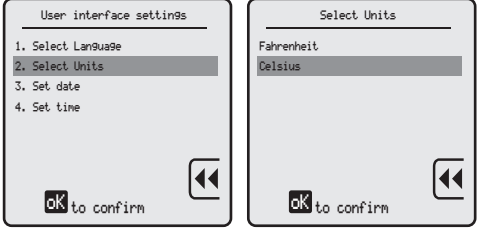

- Press  to activate the keypad for the DSP.

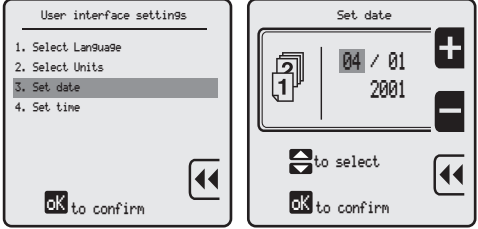







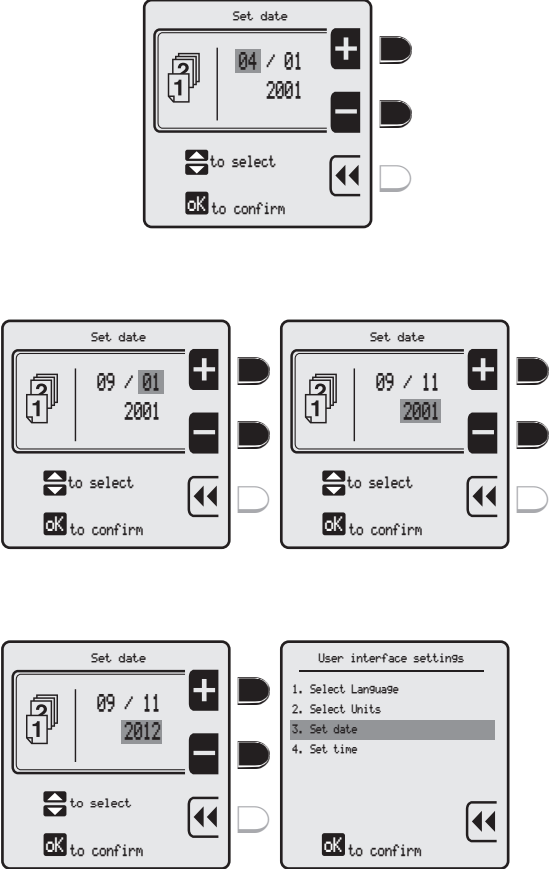



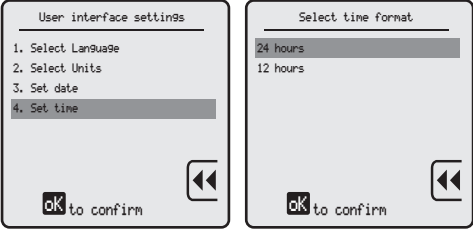
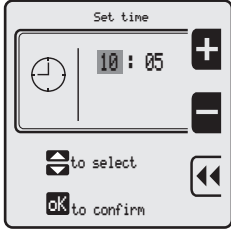

USER INTERFACE SETTINGS VIA TECHNICIAN MENU

This procedure enables the user to check or modify the LANGUAGE THE CURRENT UNIT OF MEASUREMENT and the current date and time.

Key to press	Description	Display
 	<p>to display the MENU screens</p> <p>to enter the TECHNICIAN menu, which requires entry of the PASSWORD</p>	 
 TWICE   THREE TIMES   ONCE 	<p>To enter the PASSWORD "231":</p> <p>to enter the first digit "2"</p> <p>to confirm and move to the second digit</p> <p>to enter the second digit "3"</p> <p>to confirm and move to the third digit</p> <p>to enter the third digit "1"</p> <p>to confirm the password and enter the menu</p>	 
 TWICE 	<p>to select "3. SYSTEM SETTINGS"</p> <p>to confirm and access the selected line</p>	 
 ONCE 	<p>to select "2. User interface settings"</p> <p>to confirm and access the selected line</p>	 
  	<p>to confirm and access the selected line</p> <p>to modify the language used</p> <p>to confirm the selection and return to line "1. Select Language"</p>	 

Key to press	Description	Display
   	<p>to select "2. Select Units"</p> <p>to confirm and access the selected line</p> <p>to modify the unit of measurement to be used</p> <p>to confirm the selection and return to line "2. Select Units"</p>	
 	<p>to select "3. Set date"</p> <p>to confirm and access the selected line</p>	
 OR   OR   OR  	<p>to set the current day</p> <p>to select the month</p> <p>to set the current month</p> <p>to select the year</p> <p>to set the year</p> <p>to confirm the settings and return to line "3. Set date"</p>	

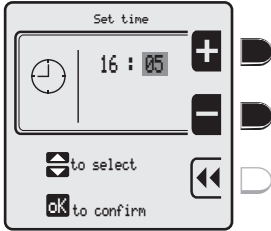
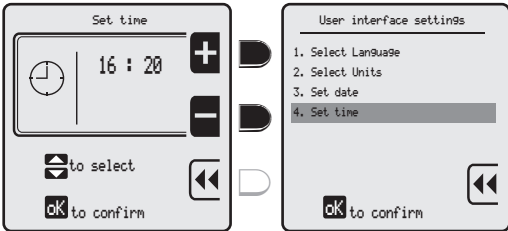
Key to press	Description	Display
   	<p>to select "4. Set time"</p> <p>to confirm and access the selected line</p> <p>to modify the time format used</p> <p>to confirm and access the selected line</p>	 
 OR   OR   OR  	<p>to set the current time</p> <p>to select the minutes</p> <p>to set the minutes</p> <p>to confirm the settings and return to line "4. Set time"</p>	 

CHECKING / MODIFYING FACTORY SETTINGS

The appliance leaves the factory with the settings as described in the paragraph "Technician menu navigation tree" on page 33. If the factory settings are not optimal for the specific system to be managed, follow the navigation tree to locate the value to be modified.

GAS CHANGE

MULTIPARVA 3.0 F appliances leave the factory set up for operation with G20 but they have the option of operating with G31 using an additional kit to be ordered separately.

The Gas change on M155HE.70/F (all models) requires the substitution of the venturi and it requires the following procedure:



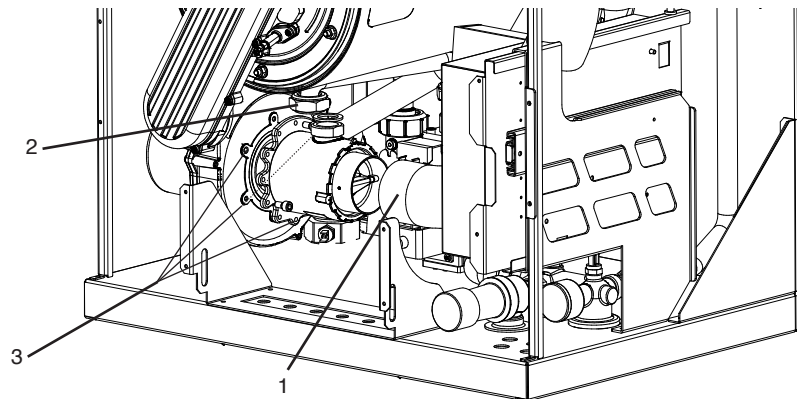





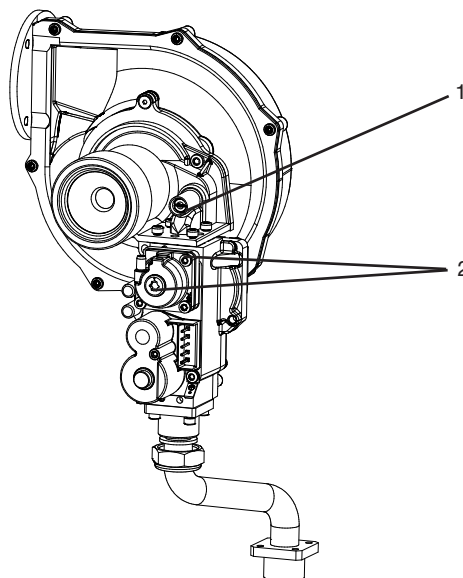



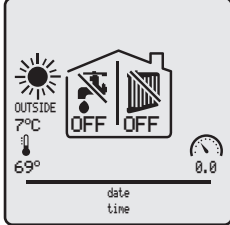
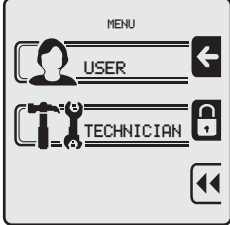

- loosen the clamp on the venturi and remove the intake pipe (1);
- loosen the nuts of the gas pipe from the gas valve to the venturi inlet (2);
- screw off the three Allen screws on the venturi and remove it;
- install the new venturi. Pay attention at the rubber gasket of the fan;
- reconnect the gas pipe with gaskets and close the pipe nuts.
- reconnect the intake pipe and close the clamp.
- after the installation of the kit, continue with the following instructions and set the gas valve as described at pag. 52; Check the absence of gas leaks.



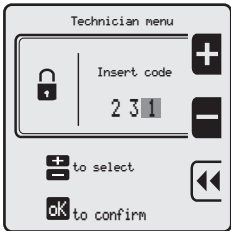



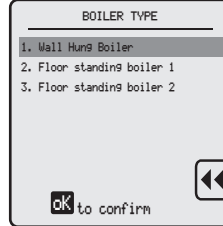

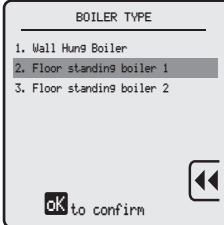
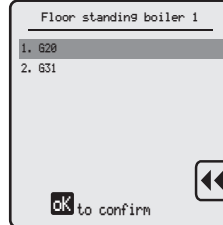
The gas change on M154HE.35/F and M154HE.45/F (all models) requires no conversion kit. The gas change can be done directly on the boiler.

- find the Allen screw on the mixer venturi, above the gas valve;
- screw it until it is blocked (about 14 rounds).
- turn on the boiler and continue with the following instructions and set the gas valve as described at pag. 52.

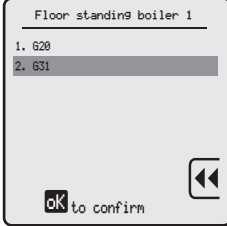
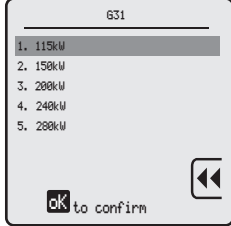

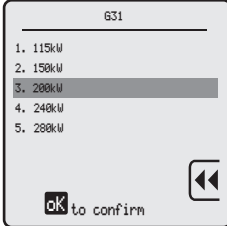
Key to press	Description	Display
 	<p>to display the MENU screens</p> <p>to enter the TECHNICIAN menu, which requires entry of the PASSWORD</p>	 
 TWICE   THREE TIMES   ONCE 	<p>To enter the PASSWORD "231":</p> <p>to enter the first digit "2"</p> <p>to confirm and move to the second digit</p> <p>to enter the second digit "3"</p> <p>to confirm and move to the third digit</p> <p>to enter the third digit "1"</p> <p>to confirm the password and enter the menu</p>	 
 7 TIMES 	<p>to select "8. BOILER TYPE"</p> <p>to confirm and access the selected line</p>	 
 	<p>to select "2. Floor standing boiler 1"</p> <p>to confirm and access the selected line</p>	 

Key to press	Description	Display
 	<p>to select "2. G31"</p> <p>to confirm and access the selected line</p>	 
 	<p>to select the output corresponding to the appliance model</p> <p>to confirm the selection and return to the INITIAL screen.</p>	 



The setting of the "gas change" parameter AUTOMATICALLY sets the blower RPM as stated in the table.









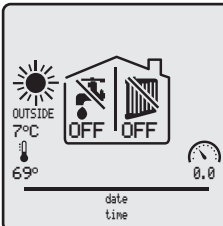
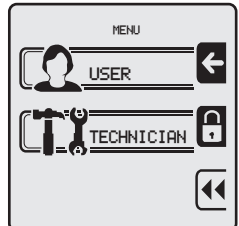





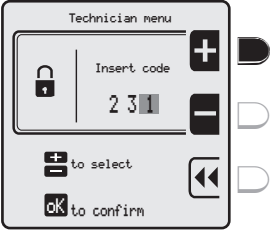

DESCRIPTION		MULTIPARVA 3.0			
		35/F	45/F	70/F	
Speed at nominal heating capacity.	G20	1200	1200	1400	rpm
Speed at minimum heating capacity.	G20	4500	5700	7400	rpm
Speed at nominal heating capacity.	G31	1200	1200	1400	rpm
Speed at minimum heating capacity.	G31	4500	5700	7400	rpm

The speed setting for ignition heating output for LPG is made by modifying the parameter on the level "3.1.1 IGNITION POWER" in the technician menu.

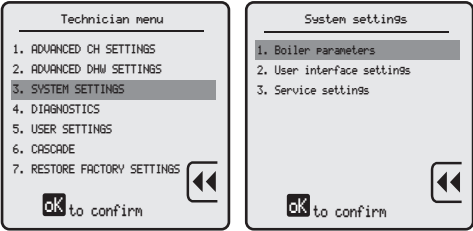
DESCRIPTION		MULTIPARVA 3.0			
		35/F	45/F	70/F	
Ignition heating input	G20	49	36	33	%
Ignition heating input	G31	61	45	55	%

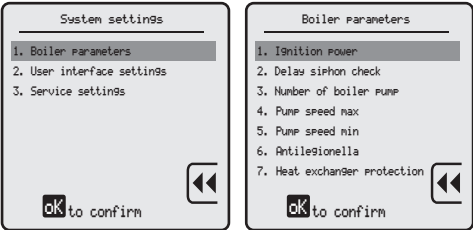



To do this, proceed as follows:

Key to press	Description	Display
 	<p>to display the menu SCREENS</p> <p>to enter the TECHNICIAN menu, which requires entry of the PASSWORD</p>	 

Key to press	Description	Display
<p> TWICE</p> <p></p> <p> 3 TIMES</p> <p></p> <p> ONCE</p> <p></p>	<p>To enter the PASSWORD "231":</p> <p>to enter the first digit "2"</p> <p>to confirm and move to the second digit</p> <p>to enter the second digit "3"</p> <p>to confirm and move to the third digit</p> <p>to enter the third digit "1"</p> <p>to confirm the password and enter the menu</p>	 
<p> 3 TIMES</p> <p></p>	<p>to select "3. SYSTEM SETTINGS"</p> <p>to confirm and access the selected line</p>	
<p></p> <p></p>	<p>to confirm and access the selected line</p> <p>to select "1. Ignition power"</p>	
<p> OR</p> <p></p> <p></p>	<p>to increase or decrease the power (from 0 to 100%)</p> <p>to confirm</p>	

To check the blower speed, at the maximum and/or minimum flow rate, proceed as described in the next paragraph (BOILER IGNITION and MANUAL TEST function).

After setting the maximum and/or minimum boiler output, press:

-  to return to "3.Manual Test"
-  twice to select "1.Boiler information"
-  to enter the Diagnostics screen
-  ten times, to select "11. Blower Speed".

Check that this value corresponds to the value stated in the table above.

- Press  to return to the "Diagnostics" screen and repeat "3.Manual Test" for the other output setting.

BOILER IGNITION



To start up the boiler:

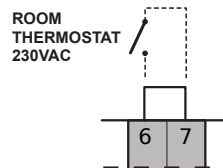





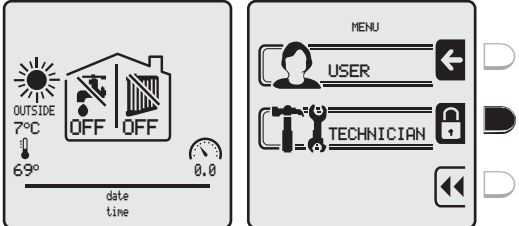







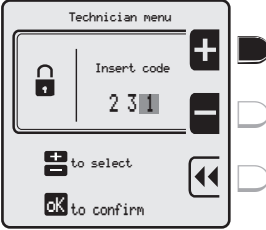

- Ensure that a jumper is wired in or that an on-demand room thermostat is set between terminals 7 and 8. The boiler will not work without these conditions.

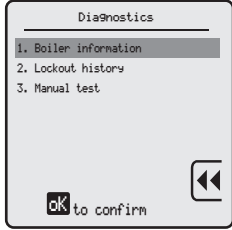

MANUAL TEST function

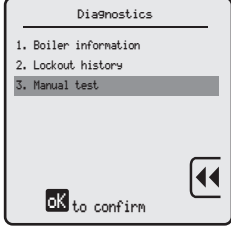
This procedure enables the user to override a heating cycle, with settable power, for a maximum duration of 15 minutes

Key to press	Description	Display
	to display the MENU screens	
	to enter the TECHNICIAN menu, which requires entry of the PASSWORD	

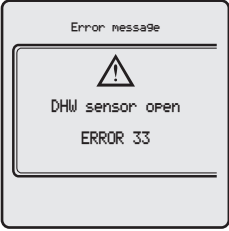
Key to press	Description	Display
 TWICE   3 TIMES   ONCE 	To enter the PASSWORD "231": to enter the first digit "2" to confirm and move to the second digit to enter the second digit "3" to confirm and move to the third digit to enter the third digit "1" to confirm the password and enter the menu	 
 3 TIMES 	to select "4. DIAGNOSTICS" to confirm and access the selected line	 
 TWICE 	to select "3. Manual test" to confirm	
  OR 	to start the test (maximum duration 15 minutes) to increase or decrease the power (from 0 to 100%)	
	Perform all checks as described in section "OPERATIONAL CHECKS - CALIBRATION AFTER GAS TYPE CHANGES" on page 52	
	to deactivate the MANUAL TEST function	

In the event of a malfunction, the appliance applies a **Safety block** or **Safety stop**, depending on the type of error/fault that has occurred, as signalled on the DSP display.

Errors with safety block

The table below lists the errors/faults that generate a Safety Block.

To restore normal operating conditions:

- Disconnect the electrical and gas power supplies from the appliance
- Eliminate the cause of the fault
- Restart the appliance.

Display items		Meaning
Failed ignition	Error 1	The flame has not been ignited within the appliance safety interval, 3 times consecutively
False flame	Error 2	False flame detection
High Boiler Temperature	Error 3	The appliance safety thermostat has tripped due to high temperature
APS Failure	Error 4	APS has not opened and/or closed within the set time (50s)
Blower speed	Error 5	The blower speed has not been detected
APS Error	Error 6	APS Failure (Error 4) for 5 consecutive times
Flame circuit	Error 8	Flame detection (circuit) error
Gas valve circuit fault	Error 9	Gas valve (circuit) error
	Error 13	Repeated errors exceeding 5 manual resets in less than 15 minutes Also in this case, turn the appliance off and on again to reset.
Internal control fault	Error 21	Fault on internal equipment/board
CRC connection	Error 25	CRC connection error
Supply sensor shorted	Error 30	The supply sensor has detected a temperature outside the admissible range (equivalent to short circuit)
Supply sensor open	Error 31	The supply sensor has detected a temperature outside the admissible range (equivalent to short circuit)
Return sensor shorted	Error 43	The return sensor has detected a temperature outside the admissible range (equivalent to short circuit)
Return sensor open	Error 44	The return sensor has detected a temperature outside the admissible range (equivalent to short circuit)

Errors with safety stop

The table below lists the errors/faults that generate a Safety Stop.

To restore normal operating conditions:

- Disconnect the electrical and gas power supplies from the appliance
- Eliminate the cause of the fault

The appliance restarts automatically on the first heat request.

Display items		Meaning
	Error 7	Flue temperature over limit
ΔT Supply/Return high	Error 11	ΔT Supply/Return > 5°C for at least 5 seconds, on stand-by, measured continuously
	Error 15	On start-up: (Supply T. - Ret. T.) > 3°C
	Error 16	On start-up, the supply T. does not vary by at least 1°C
	Error 17	On start-up, the return T. does not vary by at least 1°C
	Error 18	General sensor error, reading off scale
DHW sensor shorted	Error 32	The DHW sensor has detected a temperature outside the admissible range (equivalent to short circuit)
DHW sensor open	Error 33	The DHW sensor has detected a temperature outside the admissible range (equivalent to short circuit)
Low voltage	Error 34	The mains voltage is low (V<230-15%)
Low water pressure	Error 37	The water pressure switch detects/signals low pressure
Water pressure error	Error 41	The frequency of water pressure update is insufficient
Flue sensor shorted	Error 45	The flue sensor has detected a temperature outside the admissible range (equivalent to short circuit)
Flue sensor open	Error 46	The flue sensor has detected a temperature outside the admissible range (equivalent to short circuit)

Display items		Meaning
Water pressure switch	Error 47	The water pressure switch is disconnected or damaged
Siphon error	Error 77	The pressure switch detects high pressure (siphon abnormal filling or high pressure inside combustion chamber)
	Error 80	Ret. T. > Supply T.
	Error 81	Test in progress on temperature difference between sensors If the test fails, Error 15 is displayed.
	Error 82	The heat exchanger sensor has shorted or detected a temperature outside the admissible range (equivalent to short circuit)
	Error 83	The heat exchanger sensor is detached or has detected a temperature outside the admissible range (equivalent to short circuit)
	Error 84	High heat exchanger temperature (heat exchanger T > Supply T +10°C)
	Error 89	Incompatible programming (e.g. Max< Min.)
	Error 91	Cascade sensor in DC
	Error 92	Cascade sensor in AC
	Error 93	Outside sensor in DC
	Error 94	Error in display board
	Error 95	General cascade sensor error
	Error 96	Outside sensor in AC
	Error 97	Cascade connection defective
	Error 98	Boiler bus connection error
	Error 99	Internal boiler bus error
	Error 100	Boiler configuration error

OPERATIONAL CHECKS - CALIBRATION AFTER GAS TYPE CHANGES

For the gas change procedure, see the specific section on page 49.

To perform the operational checks and/or calibration after a gas change, proceed as follows:

- Activate the MANUAL TEST function and press  to increase power to 100% (see section "MANUAL TEST function" on page 49). This sets the heating unit to operate at **Maximum Capacity**.
- Measure the gas flow rate, taking into account any relevant corrective factors.
- Use the analyser to take CO₂ and CO readings.

The test hole for flue analysis must be made on the straight section of the flue duct at a distance of at least twice the diameter from the appliance outlet (refer to current standards. Alternatively a FLUE TEST KIT is available, to be ordered separately). Compare the readings with those stated in the table below, considering a tolerance of $\pm 5\%$.

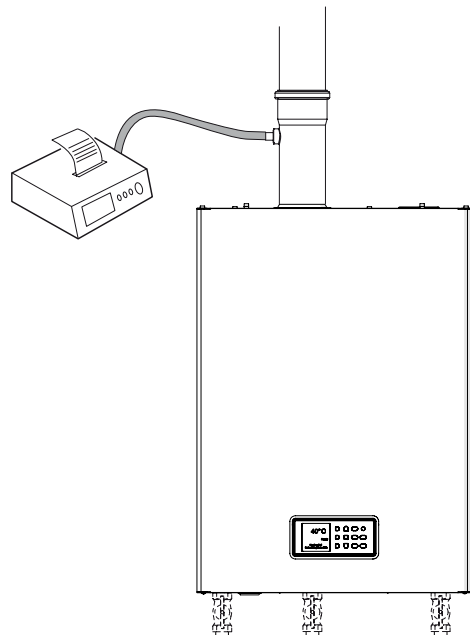

If these do not correspond, gradually adjust the MAX gas adjuster screw on the gas valve until the analyser shows the correct combustion values.

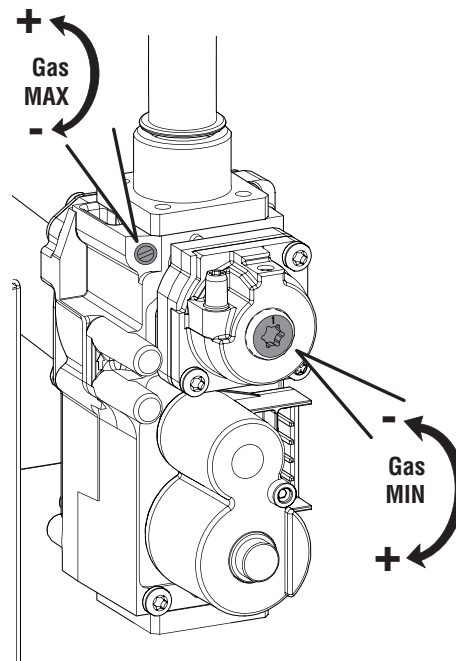

MULTIPARVA 3.0 F Gas Valve

- Press  to reduce power to 0% (see section "MANUAL TEST function" on page 49). This sets the heating unit to operate at **Minimum Capacity**.
- Measure the gas flow rate, taking into account any relevant corrective factors.
- Use the analyser to take CO₂ and CO readings.

Compare the readings with those of the table on the previous page.

If these do not correspond, gradually adjust the MIN gas adjuster screw on the gas valve until the analyser shows the correct combustion values.

Press  to deactivate the MANUAL TEST function.

If necessary, make adjustments both at the maximum and minimum values.

DESCRIPTION		MULTIPARVA 3.0			
		35/F	45/F	70/F	
Max. gas consumption	G20	3,7	4,7	7,4	m3/h
Min. gas consumption	G20	0,5	0,5	0,8	m3/h
Max. gas consumption	G31	1,4	1,9	2,7	m3/h
Min. gas consumption	G31	0,2	0,2	0,3	m3/h
CO ₂ min/max	G20	8,8/9,1	8,8/9,1	9,1/9,4	%
CO ₂ min/max	G31	9,6/9,9	9,6/10,1	9,8/10	%

The gas consumption using network gas can be lower compared to the table values, according to the quality/composition of the distributed natural gas.

WARNINGS

- If the control values are not accessible, check that:
 - the flue extraction ducts or air intake ducts are not obstructed;
 - the gas pressure is not lower than 18 mbar (G20) or 25 mbar (G31);
 - the blower RPM is correct.

Outside sensor and climatic curve

When operation envisages the use of the outside sensor ("sliding temperature") the MAXIMUM and MINIMUM SUPPLY TEMPERATURES MUST BE SET, AS WELL AS the outside temperature RANGE so that the appliance can calculate the climatic curve on the basis of these settings.

The procedure is as follows:

- Enter the Technician Menu (see page 33)
- Enter "1. ADVANCED CH SETTINGS" and proceed to line "2. CH temperatures" (see page 34)
- Press **ok** and check the existing values
- If these need to be modified, select and enter the relevant line to be modified
- Modify the value and press **ok** to confirm.
- Press **←**
- Select "3. OTC parameters"
- Press **ok** and check the existing values
- If these need to be modified, select and enter the relevant line to be modified
- Modify the value and press **ok** to confirm.

IMPORTANT

After setting/entering the optimal values, enter lines 4. OTC setpoint table and 5. OTC curve, to display the appliance operating mode and make further corrections if necessary (it may be necessary to wait for around one minute to enable the system to update all data).

- Press **←** to return to the initial line
- Select "6. DHW request type"
- Press **ok**
- Select "outside sensor" and press **ok** to confirm.

The outside temperature can always be read on the initial display screen.

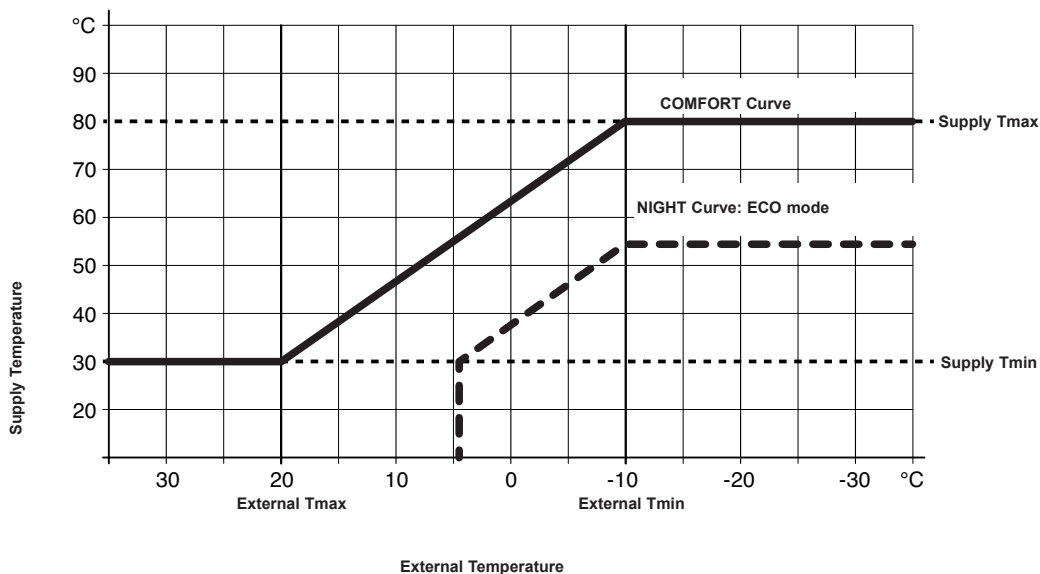



Example with radiators

TECHNICIAN MENU	Keys	Sub-menu	Keys	Lines	Keys	Suggested value
1. CH SETTINGS 	ok	1. CH power set	ok	1. Maximum power 100%	ok	100%
			▼	2. Minimum power 0%	ok	0%
	▼	2. CH temperatures	ok	1. ABS max temperature	ok	80°C
			▼	2. CH maximum setpoint	ok	75°C
			▼	3. CH minimum setpoint	ok	40°C
			▼	4. CH setpoint hysteresis	ok	3°C
	▼	3. OTC parameters	ok	1. Outside temp for max CH	ok	-5°C
			▼	2. Outside temp for min CH	ok	18°C
			▼	3. Outside temp for CH off	ok	20°C
			▼	4. OTC setpoint table	ok	read only
			▼	5. OTC curve	ok	read only
			▼	6. Request type	ok	External Sensor

Example with underfloor heating

TECHNICIAN MENU	Keys	Sub-menu	Keys	Lines	Keys	Suggested value
1. CH SETTINGS 	ok	1. CH power set	ok	1. Maximum power 100%	ok	100%
			▼	2. Minimum power 0%	ok	0%
	▼	2. CH temperatures	ok	1. ABS max temperature	ok	45°C
			▼	2. CH maximum setpoint	ok	40°C
			▼	3. CH minimum setpoint	ok	30°C
			▼	4. CH setpoint hysteresis	ok	3°C
	▼	3. OTC parameters	ok	1. Outside temp for max CH	ok	-5°C
			▼	2. Outside temp for min CH	ok	18°C
			▼	3. Outside temp for CH off	ok	20°C
			▼	4. OTC setpoint table	ok	read only
			▼	5. OTC curve	ok	read only
			▼	6. Request type	ok	External Sensor

Example with fan coil system

TECHNICIAN MENU	Keys	Sub-menu	Keys	Lines	Keys	Suggested value
1. CH SETTINGS  	ok	1. CH power set	ok	1. Maximum power 100%	ok	100%
			▼	2. Minimum power 0%	ok	0%
	▼	2. CH temperatures	ok	1. ABS max temperature	ok	65°C
			▼	2. CH maximum setpoint	ok	60°C
			▼	3. CH minimum setpoint	ok	50°C
			▼	4. CH setpoint hysteresis	ok	3°C
	▼	3. OTC parameters	ok	1. Outside temp for max CH	ok	-5°C
			▼	2. Outside temp for min CH	ok	18°C
			▼	3. Outside temp for CH off	ok	20°C
			▼	4. OTC setpoint table	ok	read only
			▼	5. OTC curve	ok	read only
			▼	6. Request type	ok	External Sensor

⚠ Check the temperatures after 15 days and change the setting if necessary.

0..10V input check

IMPORTANT PRELIMINARY INFORMATION

When an external controller is used with a 0÷10V signal for power control, it is essential that the system, on the supply side, is fitted with an additional temperature sensor, to be connected to the external controller. THIS must therefore be installed if not already present.

SETTINGS ON DSP

The settings required on the DSP to select the control function with 0÷10V controller are:

- Enter the Technician Menu (see page 33)
- Enter "1. ADVANCED CH SETTINGS" and proceed to line "6. Request type" (see page 34)
- Then select "**0-10V signal [%]**" (power request) or "**0-10V signal [SP]**" (temperature request).

With these settings, the appliance heating power / temperature is managed directly by the 0÷10V signal as follows:

- | | | |
|----------------------------|-----------------------------------|---|
| A) with voltage increase | voltage < 2V | ---> OFF |
| | $2V \leq \text{voltage} \leq 10V$ | ---> linear variation of Power or Temperature |
| B) with voltage decreasing | $2V \leq \text{voltage} \leq 10V$ | ---> linear variation of Power or Temperature |
| | $1V \leq \text{voltage} < 2V$ | ---> Minimum Power or Minimum Temperature |
| | voltage < 1V | ---> OFF |

In both modes, climatic control is managed by the external controller, and therefore to avoid problems of overlapping time bands, at least one of the following conditions must apply:

- the Timer is disabled
- the Timer is enabled but not set to "OFF" mode

To modify the functions on level "3.Scheduler settings":

- Enter the Technician Menu (see page 33)
- Select "5.USER SETTINGS" (see page 36)
- Enter the line "1.Heating" and proceed to the line "3.Scheduler settings"

IMPORTANT

The heating function (CH) must always be active (not disabled).

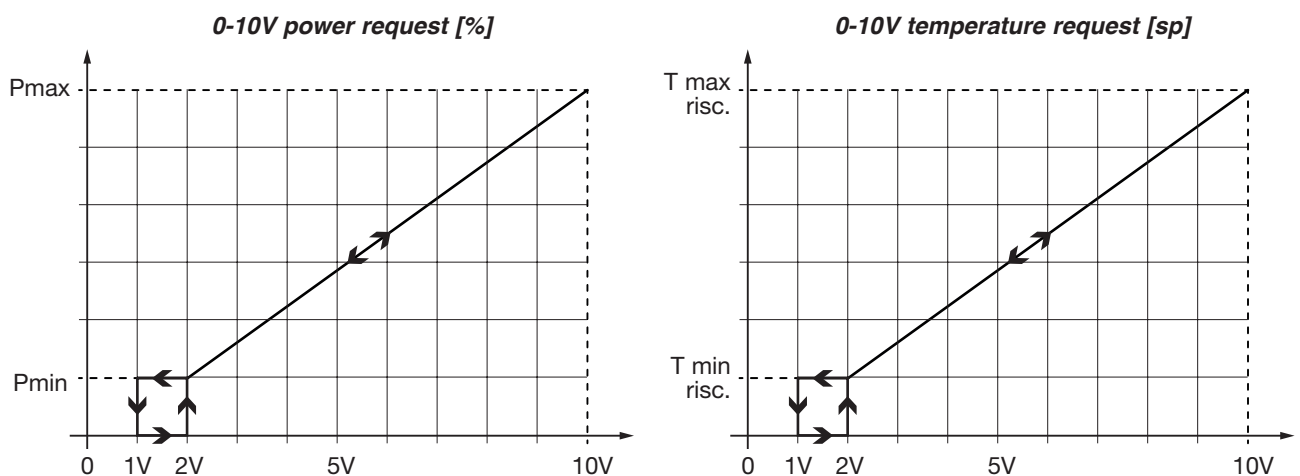

DHW request type

Depending on the selected device used (parameter Heating 1.6), the following table shows the priorities according to the conditions of the room thermostat and Scheduler settings.

		CH Demand		
		Only OTC	Room thermostat	0-10V (power or temperature)
INSTALLATION AT contact closed	Scheduler ENABLED	The heating unit follows the Scheduler settings, observing the bands set as ON, ECO and OFF. The temperature is modulated on the basis of the outside temperature.	The heating unit follows the Scheduler settings, observing the bands set as ON, ECO and OFF. If = OFF => Request disabled, heating unit on stand-by; If = ON => Request enabled, fixed setpoint at set Tmax*; If = ECO => Request enabled, fixed setpoint at the temperature corresponding to ECO mode	Request enabled, setpoint depending on 0-10V signal
	Scheduler DISABLED	Request enabled, setpoint corresponding to ON mode (comfort). The temperature is modulated on the basis of the outside temperature.	Request enabled, fixed setpoint at set Tmax*;	
AT contact open	Scheduler ENABLED	Request disabled, heating unit on stand-by	Request disabled, heating unit on stand-by	Request disabled, heating unit on stand-by
	Scheduler DISABLED	Request enabled, setpoint corresponding to ECO mode The temperature is modulated on the basis of the outside temperature.		

(*) Tmax = Set maximum temperature (see parameter 1.2.2 technician menu)













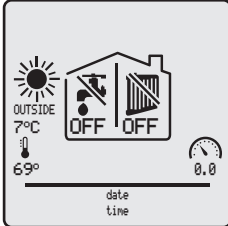
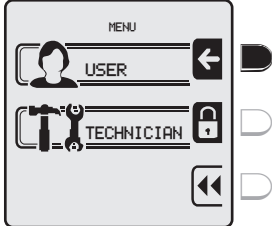



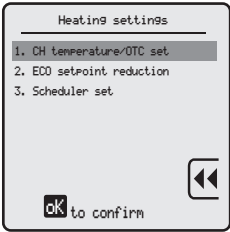

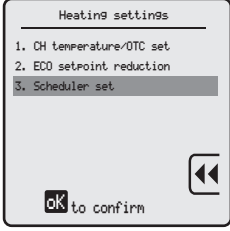
This operating mode applies regardless of whether the AT is high voltage or low voltage (see page 9)).

SCHEDULER SETTINGS

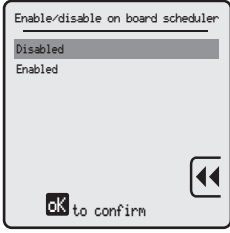
The system also envisages the option of setting time bands during which the boiler is set to operate, if there is a demand for heat, and those during which it remains off, or in ECO mode when fitted with an outside sensor.

There is a maximum of 6 programmable time bands within 24 hours, each of which must be identified by a start time (ON), and end time (OFF). The minimum interval between each time is half an hour.

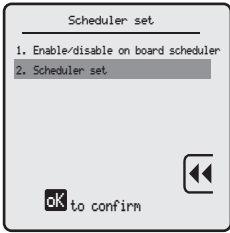
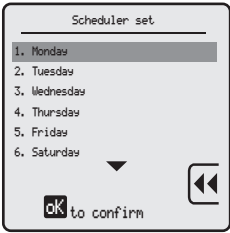
Key to press	Description	Display
 	<p>to display the MENU screens</p> <p>to enter the USER MENU</p>	 
  	<p>to select "1. HEATING"</p> <p>or</p> <p>to select "2. DOMESTIC HOT WATER"</p> <p>NOTE: the scheduler setting procedure is the same for both functions.</p>	 
 TWICE 	<p>to select "3. Scheduler set"</p> <p>to confirm and access the selected line</p>	 
  	<p>to select Enabled or Disabled</p> <p>to confirm the selection and return to line "1. Enable/disable on board scheduler"</p> <p>CAUTION: if the selection is DISABLED, the scheduler settings are memorised but not enabled.</p>	 
 	<p>to select "3. Scheduler set"</p> <p>to confirm and access the selected line</p>	 

Key to press	Description	Display
 	<p>to select the single day or group of days in the week</p> <p>to confirm and access the selected line</p>	
OR 	<p>to set the "start" time of the first band</p> <p>to set the "end" time of the first band</p> <p>to select the operating mode of the first time band, from ON, ECO or -- (boiler OFF)</p> <p>to go to the second time band To enter the settings, proceed in the same way as with the first band.</p> <p>NOTE: the time entry procedure is the same for all selected time bands.</p>	
 	<p>to select "Save and exit" or "Copy to the Next Day" (if the user wishes to copy the current settings to the next day)</p> <p>to save the settings made and return to the line of the single day or group of week days selected previously</p>	
 	<p>to select the day or days remaining and set the required time bands</p> <p>to confirm and access the selected line</p> <p>NOTE: the time entry procedure is the same for all selected time bands.</p>	













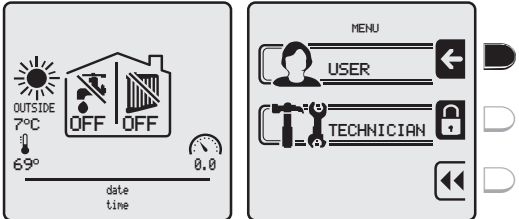

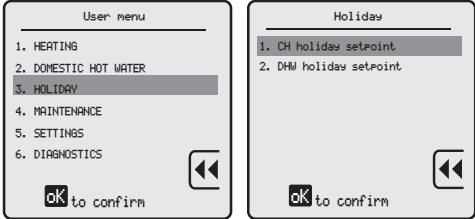
TEMPORARY SHUTDOWN OR HOLIDAY SCHEDULE

This function enables a reduction in the operating regime of the boiler in the case of temporary absences, weekends, holidays and above all automatic restart after the set time interval.

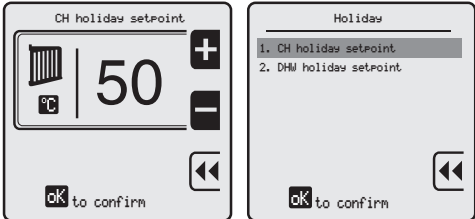





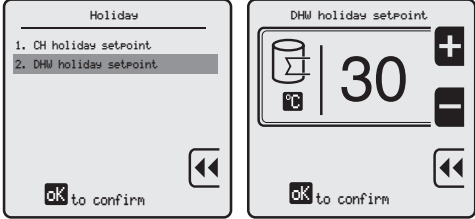





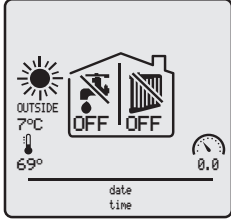





WARNINGS

- During the holiday period, it is essential to leave the electrical and gas mains supplies to the appliance powered, to ensure correct operation.

The supply temperatures for the heating system and/or production of domestic hot water, must be set as described below

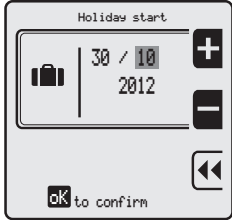
Key to press	Description	Display
 	<p>to display the MENU screens</p> <p>to enter the USER MENU</p>	
 TWICE 	<p>to select "3. HOLIDAY"</p> <p>to confirm and access the selected line</p>	
  OR  	<p>to select "1. CH holiday setpoint"</p> <p>to set the required value</p> <p>to confirm the settings and return to line "1. CH holiday setpoint"</p>	
   OR  	<p>to select "2. DHW holiday setpoint"</p> <p>to confirm and access the selected line</p> <p>to set the required value (only in the case of storage tanks with sensor) (*)</p> <p>to confirm the settings and return to line "2. DHW holiday setpoint"</p>	

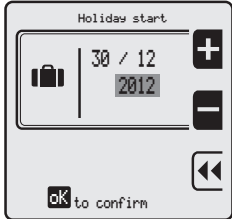
(*) In the case of storage tanks with thermostat, take care not to set an excessively low value, as this could cause continuous requests for domestic hot water.

Key to press	Description	Display
 	<p>to return to the initial screen</p> <p>to display the "Holiday start" date</p>	 
<p> OR </p> <p></p> <p> OR </p> <p></p> <p> OR </p> <p></p>	<p>to set the holiday start day</p> <p>to select the month</p> <p>to set the month</p> <p>to select the year</p> <p>to set the year</p> <p>to confirm the settings made and enter the "Holiday end" screen.</p> <p>NOTE: to make the settings for the day, month and year of the holiday end, follow the same procedure as described for "Holiday start".</p>	     

MAINTENANCE AND CLEANING

Periodic maintenance is a compulsory legal requirement and is essential to ensure optimal safety, performance and lifetime of the appliance.

Internal cleaning of the appliance and removal of combustion residue from the exchange surfaces are operations required **at least once a year**. This is an essential condition to reduce consumption, pollutant emissions and to maintain optimal performance.

Before starting maintenance and/or cleaning:

- Set the main system switch (IG) to "OFF"
- Close the fuel shut-off valves.

EXTERNAL CLEANING

The outer casing should be cleaned with cloths dampened with water and detergent. In the case of stubborn stains, dampen a cloth with a mix of 50% water and denatured alcohol or with special products.

After cleaning, dry the appliance thoroughly.

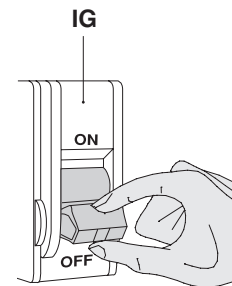

WARNINGS

- If replacing parts, use **EXCLUSIVELY** original spare parts.
- Never use abrasive products, benzene or trichloroethane.

INTERNAL CLEANING

To ensure correct operation of the appliance, the burner and flue lines in the exchanger need to be cleaned periodically. It is indispensable to mechanically and completely remove the dirt from the exchanger to avoid the possible formation of scale during the lifetime of the boiler. If necessary, chemically remove all residue using products compatible with steel (the material of the heat exchanger).

At the end of cleaning, remove/vacuum all residue.

IF IN DOUBT, CONTACT BIASI BOILERS FOR ASSISTANCE.

Cleaning the primary condensing heat exchanger and burner

Removing the blower-burner assembly (A)

- Remove the front panel of the boiler
- Disconnect the wiring of the ignition electrodes (1) and flame detector electrode (3)

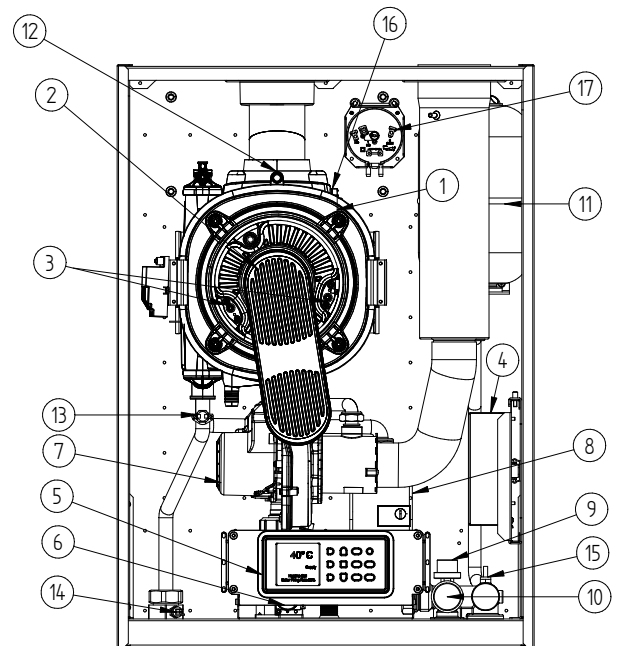

- Unscrew the gas ring nuts and remove the gas pipe
- Remove the flexible intake pipe
- Detach the blower from the electrical connections
- Remove the nuts and extract the burner-blower assembly.
- Remove all dirt from the tubes of the primary condensing heat exchanger, brushing them with a bristle brush and removing dirt with a vacuum cleaner.

The burner does not require special maintenance; simply cleaning with a bristle brush is sufficient.

More specific maintenance operations will be evaluated and performed by the Authorised Technical Services Centre.

After cleaning, re-fit all components in reverse order of the above, inserting new seals where necessary.

IMPORTANT

It is compulsory to test sealing efficiency of the gas line, as required by current standards.

WARNINGS

- The silicon seal of the front panel of the combustion chamber must be replaced if worn, and in any event should be changed ever 2 years.
- The detection electrode (2) also acts as a sensor to confirm correct condensate drainage. If this electrode comes into contact with the condensate present in the combustion chamber, it causes a safety shutdown of the boiler. Therefore if the insulation inside the combustion chamber is found to be wet or worn, replace immediately.

Checking and cleaning the condensate drain syphon

The condensate drain syphon (9) does not require special maintenance. Simply check that no solid deposits have formed inside (removing if necessary) and that the condensate drain pipelines are not obstructed.

To clean the syphon, simply unscrew cap (10) for access.

Pressure switch check

Check the correct operation of the pressure switches by gradually blowing inside the positive pressure point (+) until the activation click. Check the actual operation of the pressure switch on the contacts. Finally, check the condition of the silicone tube (internal cleaning, absence of cracks etc.)

TROUBLESHOOTING

Appliance malfunctions/faults are indicated on the display as shown in the table on page 51.

However, other anomalies may occur on the appliance/system, and these are listed below.

Fault	Cause	Remedy
Smell of gas	- Gas supply circuit	- Check sealing efficiency of the joints and closure of the pressure points
Smell of uncombusted fuel	- Flue circuit	- Check: - sealing of joints - for possible obstructions - combustion quality
Irregular combustion	- Supply gas pressure	- Check settings
	- Burner and/or exchanger dirty	- Check conditions
	- Intake and/or exhaust lines dirty	- Check conditions
	- Incorrect blower RPM	- Check the blower RPM (see page 47).
Delayed ignition with pulsing on burner	- More precise tuning of ignition power required	- Modify settings
The generator does not reach the set temperature	- Generator heat exchanger dirty	- Clean the combustion chamber
	- Insufficient burner flow rate	- Check burner settings
The generator reaches the set temperature but the heating systems are cool	- Presence of air in the system	- Purge the system
	- System pump	- Unblock the pump - Replace the pump
Frequent intervention of the system safety valve	- System safety valve	- Check setting or efficiency
	- System pressure	- Check filling pressure - Check pressure reducer - Check filling valve
	- System expansion vessel	- Check efficiency
System pump/s do not work	- Pump blocked, electrical connections	- Check pump and connections
	- Room thermostat	- Check room thermostat and connections
Storage tank pump does not work	- Pump blocked, electrical connections	- Check the pump - Check the electrical connection between the pump and control panel
	- Storage tank thermostat	- Check efficiency and position of the thermostat

END OF LIFE DISPOSAL

Outdated appliances

When you decide to permanently shutdown the boiler, please request a qualified professional to decommission the boiler & ancillary equipment. They must ensure that boiler has been disconnected from power supplies, water and gas.

This device contains potentially recyclable materials that can be reused. Components are easy to separate and for this reason, they can be processed and used for recycling or disposal.

- Electrical and electronic components no longer usable must be collected separately and recycled in an environmentally friendly way.
- Do not dispose of either the product or the accessories with household waste. Make sure that products and all accessories are disposed of in a workmanlike manner.
- Always observe all laws in force.

Attention

Gas boilers are electrical and electronic appliances (AEE) and, when dismissed, they become electrical and electronic waste (RAEE): as such, they must be disposed according to current legislation.

Gas boilers are classified as household appliances and must be disposed with washing machines, dishwashers and dryers (RAEE R2 waste).

The disassembly of gas boilers and their disposal through channels not approved is prohibited by law.

The user has the right to be able to deliver the disused gas boiler, integral in its construction, to the ecological area.

The installer and the user have the right to be able to deliver the disused gas boiler, integrated in its construction to the point of sale where they purchase the new gas boiler.

Packing

With regards to packaging; BIASI always use recyclable and ecological components.

All materials used for packaging are environmentally friendly and can be reused; please follow the recycling procedures specific for your country, which guarantee optimal recycling.

- Dispose of the packaging material of the boiler in accordance with the laws for environmental protection.

NOTE





008274467 3621 68A4 EN
17962.0296.0 3621 68A4 EN

BSG Caldaie a Gas S.p.A.

*Registered office, sales and administrative headquarters,
Plant and technical support*

Via Pravalton, 1/b – 33170 PORDENONE (Italy)

 +39 0434 238311

 +39 0434 238387

 www.biasi.it

Sales headquarters

 +39 0434 238400

Technical support

 +39 0434 238387

This manual replaces previous versions.

In order to constantly improve its products, BSG Caldaie a Gas S.p.A. reserves the right to change the data provided in this manual at any time and without notice. Product warranty pursuant to Italian Leg. Decree. no. 24/2002.